



*An Axiometrix Solutions Brand*



# Product Catalog

imc Test and Measurement Solutions

**Our Vision is ...**



**... to inspire engineers, researchers and developers with first class test and measurement solutions to improve products, systems and life around the world.**

Every day, imc DAQ systems, software solutions and test stands are used to validate prototypes, optimize products, monitor processes and gain insights from measurement data. The company offers its customers top technological performance throughout the entire measurement chain.



# Contents

## Data Acquisition Systems

Powerful, compact and scalable DAQ system – imc ARGUS <i>fit</i> .....	6
Frameless Modular Data Acquisition System – imc CRONOS <i>flex</i> .....	10
Adaptable Data Acquisition and Control System – imc CRONOS <i>compact</i> .....	14
Rugged Data Acquisition System – imc CRONOS-XT .....	18
Affordable Multi-Channel Data Acquisition System – imc SPARTAN .....	22
Handy all-in-one Data Acquisition System – imc C-SERIES .....	26
High-Speed Data Acquisition and Transient Recorder – imc EOS.....	30

## CAN Based Data Acquisition

Intelligent Multi-Bus Data Logger – imc BUSDAQ <i>flex</i> .....	34
Intelligent Measurement Modules based on CAN-Bus – imc CANSAS <i>flex</i> .....	38
Robust Measurement Modules – imc CANSAS <i>fit</i> .....	40
Wide-range Current Measurement Module – imc CANSAS-IHR.....	44

## Software

Integrated Software for the Entire Testing Process – imc STUDIO.....	46
Software for Data Analysis – imc FAMOS.....	48
Software for Sound and Vibration Measurement and NVH Analysis – imc WAVE ...	50

## Telemetry Solutions

One Channel Telemetry Systems .....	52
Universal Telemetry System for up to 24 Channels .....	53
Modular Telemetry Systems .....	54

## Sensor Solutions

Measuring Temperatures on the Brake Disc – D <sup>x</sup> -BrakeTemp .....	60
Wireless Wheel Speed Acquisition – D <sup>x</sup> -Speed .....	61
Mechanical Power Measurements on Shafts – D <sup>x</sup> -Power.....	64
Robust Wheel Force Transducers – WFT-C <sup>x</sup> .....	66
Wireless Wheel Torque Transducer – WTT-D <sup>x</sup> .....	68
High-Precision Steering Effort Sensor .....	70

<b>Services</b> .....	72
-----------------------	----



# The imc Product Portfolio

## DAQ SYSTEMS

The core of the product portfolio consists of imc's modular data acquisition and control systems that are fit for test stand and laboratory applications as well as mobile data acquisition in harsh environments.

## SENSORS AND TELEMETRY

The imc DAQ hardware can be supplemented by custom-tailored telemetry and automotive sensor systems which enable engineers to capture data, even from rotating parts.

## SOFTWARE

The imc software covers the entire test and measurement process - from data acquisition to live monitoring and test stand automation. Powerful tools help you analyze and manage your test and measurement data and create professional test reports.

## SERVICES

We offer a range of unique services, from consulting and training to customized test solutions and test benches, ensuring that our customers have everything they need to validate prototypes and products, monitor processes and machines, and collect data to gain insights.

# imc ARGUSfit

Powerful, compact and scalable DAQ system

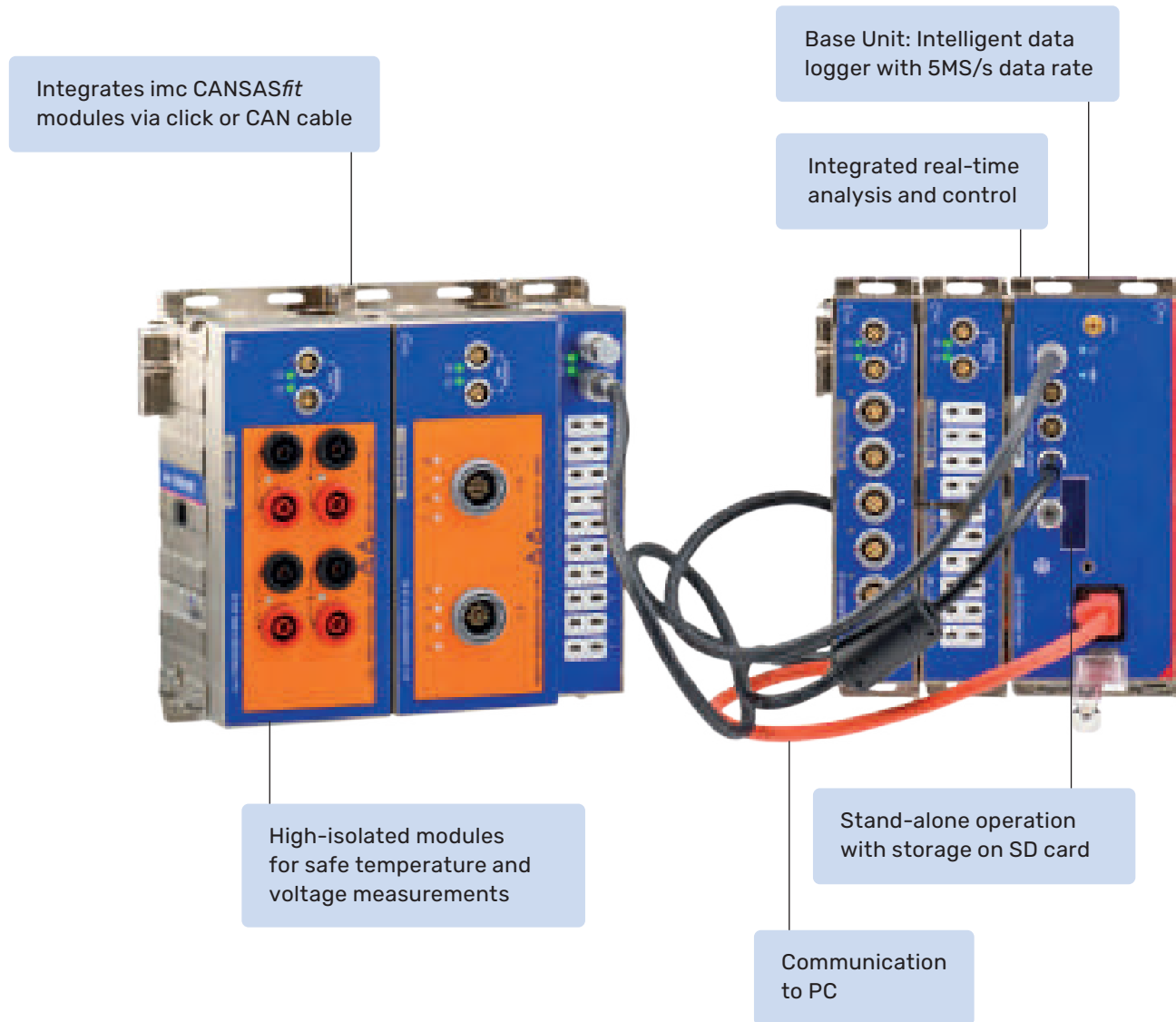

imc ARGUSfit is a **POWERFUL, ULTRA-COMPACT** and **FLEXIBLE** DAQ system where you easily connect the modules with a click mechanism. With high channel density, compact design, and stand-alone operation, it enables precise measurements in a wide range of applications – from prototype testing to monitoring machines and equipment.

## APPLICATION

Perfect for highly demanding measurements in the lab and in the field

powerful • ultra-compact • flexible



Clickable measurement modules for all common sensors

Clickable Fieldbus interface modules such as CAN-FD

Up to 500 kS/s per channel



Distributable via fiber connection over hundreds of meters

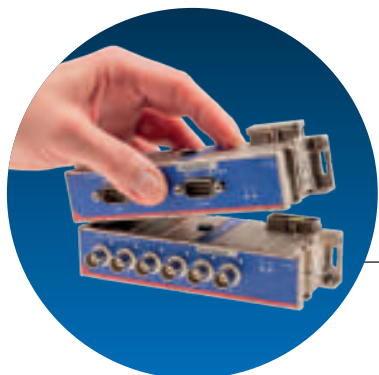

Click mechanism connects modules electrically and mechanically

With its **SCALABLE** design the DAQ system can grow with your needs. Expand its capabilities effortlessly with additional modules for analog inputs or fieldbus interfaces. Synchronously capture a wide variety of signals – whether analog sensors or digital data such as CAN-FD – and perform **REAL-TIME ANALYSIS** directly in the device.

# imc ARGUSfit Details

## imc ARGUSfit base unit

General*	
Total data rate	5 MS/s
Connectivity	
Ethernet (RJ-45)	Gigabit Ethernet
W-LAN (WiFi)	optional (in preparation)
GPS connection port	●
Synchronization port	●
Remote controlled main switch	●
CANSASfit port	●
CANSASfit modul connector (click connection)	●
ARGUSfit modul connector (click connection)	●
Data storage	
Internal storage on removable media	micro SD up to 256 GB
External storage on PC / network (NAS)	via Ethernet
Stand-alone capabilities	
Stand-alone operation	●
Auto data-saving upon power outage	●
UPS	Super-Caps
UPS coverage	ARGFT-BASE
Data Acquisition & Real-Time Fuction	
Max. aggregate sampling rate	5 MS/s
Max. channel sampling rate	depends on module type
Max. active channels within a system	1000
Channel individual sampling rates	selectable in 1–2–5 steps
Number of sampling rates	any
Monitor channels (for all channels)	●
Pre-processing for monitor channels	●
Intelligent trigger functions	●
Multi triggered data acquisition	max. 8
Real-time data analysis platform (imc Online FAMOS)	●
Synchronization & clock	
Master-slave between different imc systems	●
NTP network based synchronization	●
PTP network synchronization	in preparation
IRIG-B via external signal	●
Power	
Input supply voltage	10 - 50 V DC
AC/DC power adapter (110 to 230VAC)	●
Shutdown threshold	≤8.5 V
Power consumption	3.3 W (typ.)
Isolation	60 V
Environmental	
Operating temperature range	-40 °C to + 85 °C
Shock and vibration resistance	IEC 60068-2, IEC 61373 IEC 60062-2-64 category 1, class A and B MIL-STD-810 Rail Cargo Vibration Exposure U.S. Highway Truck Vibration Exposure
IP rating	IP50
Housing	
Dimensions	153 x 62 x 53 mm
Weight	0.5 kg



## Real-time Data Analysis Included

imc Online FAMOS is a powerful extension included in every imc ARGUSfit DAQ system as a standard without any additional license required. It offers a variety of real-time functions for pre-processing and signal analysis. The mathematical analysis functions are executed on the signal analysis platform integrated in the measurement device. This means that analysis results are available immediately and also independently of the PC. Such pre-processing can also yield significant data reduction and thus reduce the amount of data to be exchanged between the DAQ system and the PC. The results are available in imc STUDIO as virtual channels.

Key: ● Default

## imc ARGUSfit Modules



### UTI-6\*

Isolated universal voltage amplifier with sensor supply

Input types:	Voltage (25 mV to 60 V), Current (20 mA sensors), Temperature (PT100, PT1000) Resistance (e.g. NTC)
Channels:	6
ADC:	24-bit
Sampling rate	100 kS/s per channel
Sensor Supply	+/- 2.5V ... +/-15V individually configurable per channel, 0.5W per channel, 2W per module



### B-4\*

Universal isolated bridge mode and strain gauge amplifier with sensor supply

Input types:	Strain gauges, bridge-mode sensors, potentiometers Voltages (25 mV to 10 V) Active transducers that require voltage supply
Channels:	4
ADC:	24-bit
Sampling rate	100 kS/s per channel



### imc LEMO Terminal Plug

The fast, flexible and easy-to-assemble LEMO.1B connector for ARGUSfit module UTI-6 and B-4 and for CANSASfit-UTI-6 series



### ICPU-6\*

Isolated amplifier for voltage and IEPE sensors

Input types:	IEPE or ICP sensors (current fed sensors 4 mA) Voltage (25 mV to 60 V)
Channels:	6
ADC:	24-bit
Sampling rate	500 kS/s per channel



### CAN-FD\*

Isolated fieldbus modul for CAN FD

Number of CAN ports:	2
Connection:	DSUB-9
Protocols:	CAN FD (ISO 11898-1:2015) 8 MBaud CAN High Speed (ISO 11898) 1 MBaud CAN Low Speed (ISO 11519) 125 KBaud
Direction:	sending and receiving



### Fiber-Converter

Extender and media converter for the imc ARGUSfit system bus for spatial distributions

Set includes:	2 converter modules, 2x SFP+ transceiver, 5 m fiber optic cable, AC/DC power adaptor and a power cable
---------------	---



### UPS-NiMH\*

UPS for imc ARGUSfit and imc CANSASfit to bridge short-term power failures

Buffering:	Entire imc ARGUSfit system
Total Power:	50 W
Battery technology:	Robust NiMH
Buffer time:	30 sec. (several times)
External devices:	Buffering via auxiliary power output



### \*Option: -EC

For operating conditions involving dew point

# imc CRONOSflex

## Frameless Modular Data Acquisition System

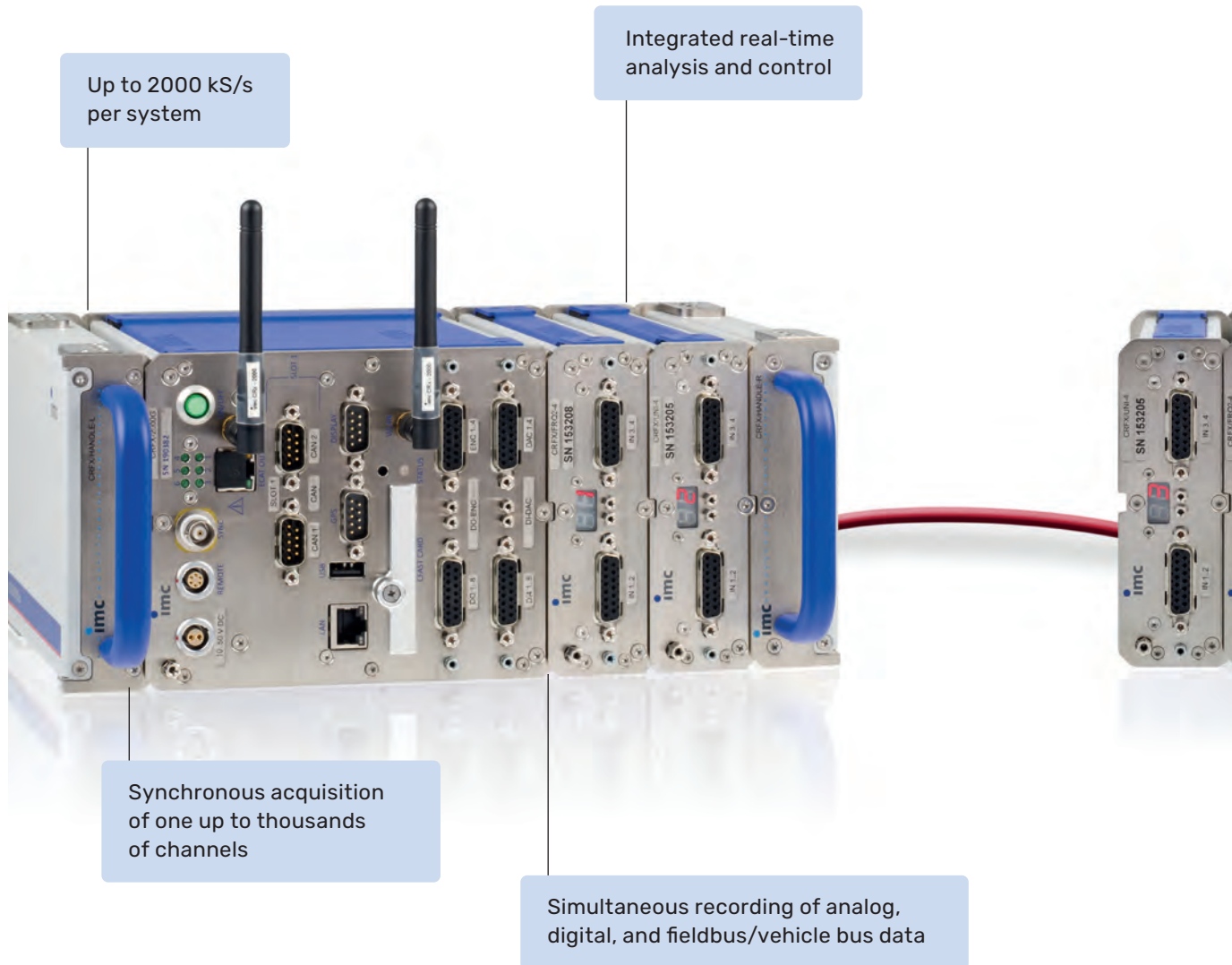

imc CRONOSflex offers you more **FLEXIBILITY** for your daily changing test tasks. By clicking imc CRONOSflex modules to a base unit, you've created a complete system, with exactly the number of channels you need. No cables between cards, no half empty mainframe rack, and no expansion chassis to squeeze in one more channel.



## APPLICATION

Ideal for comprehensive test and measurement tasks in test bench and mobile applications - in centralized or distributed installations

**flexible • expandable • fast**

Centralized or distributed as you need

Flexible modularity through frameless expansion



up to 100 kS/s per channel

Click mechanism connects modules electrically and mechanically

A perfect fit for daily changing requirements on test stands and bench tops, to mobile testing environments, the **MODULAR DAQ & CONTROL** system provides you with the versatility you need, over a diverse range of measurement and control tasks, but without the need to make any sacrifices of performance or ease of use.

# imc CRONOSflex Details

## imc CRONOSflex base unit

	CRFX-400	CRFX-2000GP
<b>General</b>		
Aggregate sampling rate	400 kSps	2000 kSps
<b>Operating conditions</b>		
Standard operating temp. range	●	●
Extended temp. range (incl. condensation)	○	○
Shock and vibration rating	MIL 810F (40g)	
<b>Connectivity</b>		
Ethernet	100 MBit	1 GBit
W-LAN (WiFi) IEEE 802.11.g (54 Mbit/s)	○	○
Dual band IEEE 802.11.n (300 Mbit/s)		○
EtherCAT distributable system bus	●	●
GPS connection port	●	●
Display connection port	●	●
Remote controlled main switch	●	●
Programmable status feedback (LEDs)	●	●
Isolated SYNC signal	●	●
<b>Data storage</b>		
CF card slot (Compact Flash)	●	
CFast card slot		●
USB 2.0 host port (external removable storage)		●
Storage on PC / network drive (NAS)	●	●
SSD (internal)	○	○
<b>Stand-alone capabilities</b>		
PC independent complex trigger functionality	●	●
Onboard real-time data analysis (imc Online FAMOS)	●	●
Autarkic PC-less operation, self start	●	●
<b>Synchronization &amp; clock</b>		
Master-slave between different imc systems	●	●
NTP network based synchronization	●	●
PTP network synchronization (precision)		●
Via external GPS signal, IRIG-B or DCF-77	●	●
<b>Field bus extensions</b>		
CAN, CAN FD	○	○
LIN	○	○
FlexRay	○	○
MVB, IPTCom	○	○
Profinet, Profibus	○	○
Modbus (RTU, TCP)	○	○
ARINC	○	○
XCPoE (Master, Slave)	○	○
EtherCAT Slave	○	○
<b>Multi-functional I/O extension of base unit</b>		
Digital in/out, pulse counter, analog out	○	○
<b>Power supply</b>		
DC input 10V to 50V	●	●
AC/DC adapter (110 to 230VAC)	●	●
Supply of remote modules via Power-over-EtherCAT	●	●
Data integrity upon power fail	●	●
UPS (NiMH battery)	○	○
UPS (extended capacity Li-Ion)	○	○



## imc CRONOSflex analog amplifier modules

module name CRFX/xxx	size		connector		speed		voltage mode			current	temp	ICP, charge, supplies			bridge mode												
	channels	width (type)	standard connector	LEMO version available	TEDS	max. sampling rate (per channel)	signal bandwidth (-3dB)	isolated voltage mode	min. voltage range (mV)	voltage up to 10 V	voltage up to 50/60 V	voltage up to 1000 V	20 mA internal shunt	20mA shunt plug	Thermocouple (TC)	RTD (PT100)	IEPE mode integrated	IEPE plug	sensor supply (per channel)	full bridge	half bridge	quarter bridge	DC excitation	AC excitation (CF)	single SENSE	double SENSE	
<b>Voltage measurement</b>																											
LV3-8	8	1	DSUB-15	○	●	100 kHz	48 kHz		5	●	●		●					○	○								
<b>Voltage &amp; temperature measurement</b>																											
IS02-8	8	1	DSUB-15	○	●	100 kHz	11 kHz	●	50	●	●		●	●	●			○	○								
IS02-8-2T	8	2	Thermo			100 kHz	1 kHz	●						●													
IS02-16-2T	16	2	Thermo			100 kHz	1 kHz	●						●													
IS02-8-L	8	2	LEMO.1B	●	●	100 kHz	11 kHz	●	50	●	●	●						○	○								
IS0F-8	8	1	DSUB-15	○	●	100 kHz	48 kHz	●	50	●	●		●					○	○								
HISO-8-L	8	3	LEMO.1P REDEL	●		100 kHz	11 kHz	●	50	●	●	●															
HISO-8-T-L	8	3	LEMO.2P REDEL	●		100 kHz	1 kHz	●						●													
<b>High voltage measurement 600V CAT III</b>																											
HV2-4U	4	3	Banana			100 kHz	48 kHz	●	2,500	●	●	●															
HV-2U2I (I-chan)	4	3	Banana/ Terminal blocks		●	100 kHz	48 kHz	●	2,500/ 50	●	●	●															
<b>Audio &amp; vibration measurements</b>																											
ICPU2-8	8	2	BNC		●	100 kHz	48 kHz		5	●	●							●									
AUDIO2-4	4	2	BNC		●	100 kHz	48 kHz	●	5	●	●							●									
<b>Bridge &amp; strain gauge measurements</b>																											
BR2-4	4	1	DSUB-15	○	●	100 kHz	14 kHz		5	●	●		●					○	(●)	●	●	●	●	●	●	●	●
B-8	8	2	DSUB-15	○	●	100 kHz	48 kHz		5	●		●	●					○	●	●	●	●	●	●	●	●	●
BC-8	8	1	DSUB-26-HD			100 kHz	48 kHz		5	●		●	●							●	●	●	●	●	●	●	●
DCB2-8	8	2	DSUB-15	○	●	100 kHz	5 kHz		5	●		●	●					○	●	●	●	●	●	●	●	●	●
DCBC2-8	8	1	DSUB-26-HD			100 kHz	5 kHz		5	●		●	●							●	●	●	●	●	●	●	●
<b>For universal use</b>																											
UNI2-8	8	2	DSUB-15	○	●	100 kHz	48 kHz		5	●	●	●	●	●	●			○	●	●	●	●	●	●	●	●	●
UNI-4	4	1	DSUB-15	○	●	100 kHz	48 kHz	●	2.5	●	●	●	●	●	●			○	●	●	●	●	●	●	●	●	●

## imc CRONOSflex DIO, pulse counter, DAC modules

module name CRFX/xxx	width	standard connector	digital I/O			DAC		pulse counter			
			input Bits	high voltage	output Bits	high current	analog outputs	counter inputs	quadrature mode chan	counter frequency	analog sin/cos mode
<b>Base unit extension</b>											
DI16-DO8-ENC4	+40mm	DSUB-15	16		8			4	2	32 MHz	
DI8-DO8-ENC4-DAC4	+40mm	DSUB-15	8		8		4	4	2	32 MHz	
<b>flex modules: pulse counter</b>											
HRENC-4	1	DSUB-15						4	4	256 MHz	●
<b>flex modules: digital I/O, DAC<sup>(c)</sup></b>											
DI2-16	1	DSUB-15	16								
DI2-32	2	DSUB-15	32								
DO-16-HV (110V)	2	Terminal blocks	16	●							
DO-16-HC	1	DSUB-15			16	●					
DO-32-HC	2	DSUB-15			32	●					
DI2-16-DO-16-HC	2	DSUB-15	16		16	●					
DAC-8	1	DSUB-15					8				
DO-16-HC-DAC-8	2	DSUB-15			16	●	8				
<b>Real-time control modules (PID, simulation, custom solutions)</b>											
SYNTH-8	1	8 independent PID controller, arbitrary signal generator (synthesizer)									
APP-MOD	1	custom programmable real-time applications, HW-interface integrations									

### TEDS support (Transducer Electronic Data Sheet)

imc CRONOSflex modules support direct read/write of TEDS sensors, including imc's TEDS Clip. Connectors: TEDS interfaces require either the ACC /DSUBTEDS-x variants of our connectors or per-channel connectors such as Lemo. "IEPE" type TEDS is supported in audio modules with direct BNC input connectors.

### Digital I/O

galvanically isolated, configurable to 24V/5V (TTL/CMOS) Level, output: 0.7A sink, high current: sink and source 0.7A

### Pulse Counter

full analog input conditioning: 500 kHz analog bandwidth, differential input, analog filter, software adjustable threshold levels. Modes: event counter, time, frequency, speed, RPM differential and absolute angle and displacement

Key: ● Default, ○ Optional, (●) Restricted

# imc CRONOScompact

Adaptable Data Acquisition and Control System

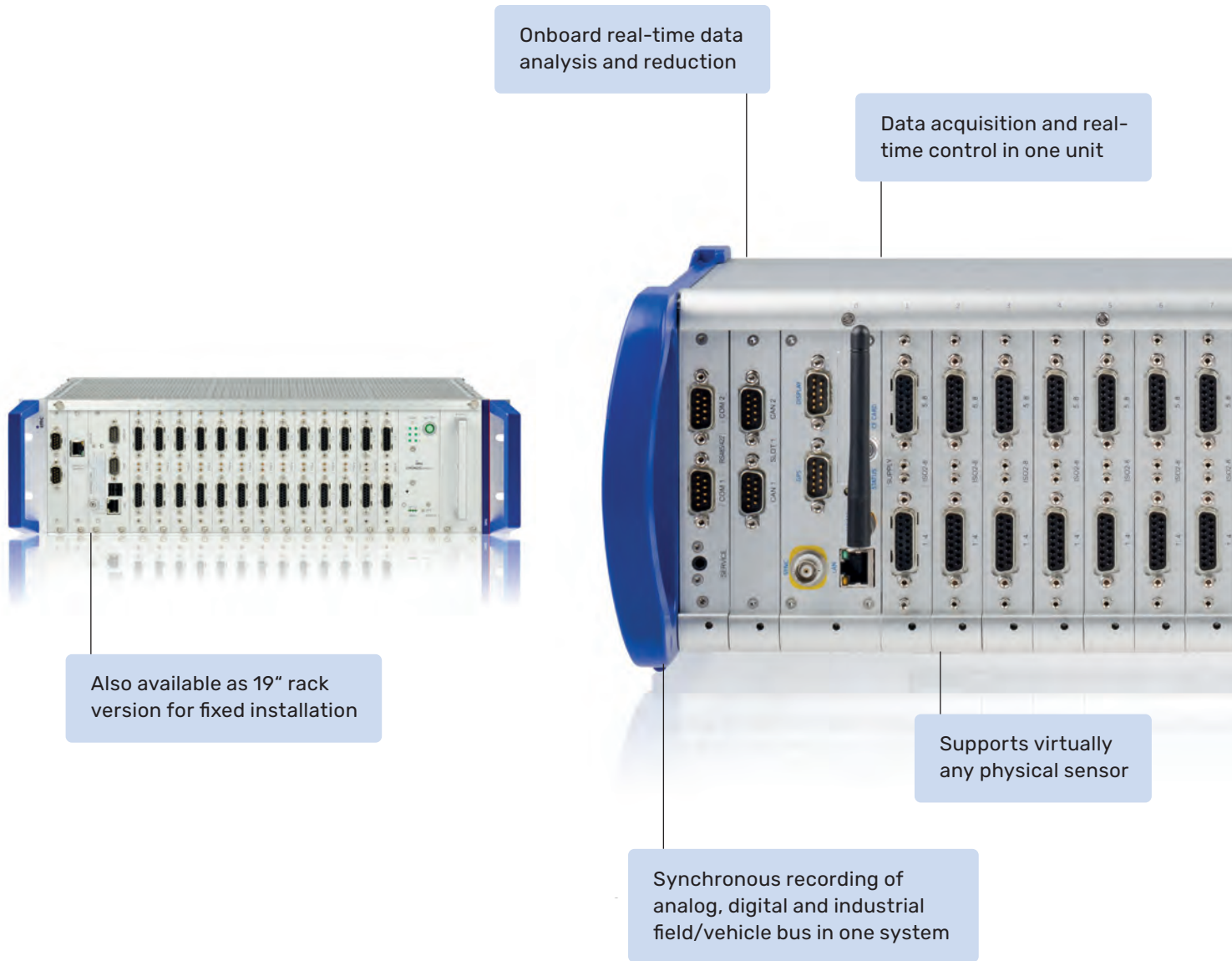

Onboard real-time data analysis and reduction

Data acquisition and real-time control in one unit

Also available as 19" rack version for fixed installation

Supports virtually any physical sensor

Synchronous recording of analog, digital and industrial field/vehicle bus in one system

The imc CRONOScompact is the single **MOST COMPREHENSIVE** DAQ and control system for electromechanical testing on the market today. Integrating measurement and real-time control into one housing provides you with the reliability of absolute synchronization, and the convenience of having all of your tools in one place.



## APPLICATION

Perfectly tailored for test bench and laboratory applications as well as for mobile use

**comprehensive • modular • reconfigurable**

Modular reconfigurable hardware adaptable to changing testing requirements



Expandable via plug-in modules or distributed synchronous CRFX modules (EtherCAT based)

Portable version with optional battery pack



Standalone, remote or interactive operation

Incorporating the complete range of modular I/O choices and **INTEGRATED SIGNAL CONDITIONING**, imc CRONOScompact provides the versatility and broad range of capabilities that allow you to achieve the highest levels of productivity in your testing. All this capability is available in **MODULAR AND RECONFIGURABLE** compact housings or 19" rack systems.

# imc CRONOScompact Details

## imc CRONOScompact mainframe/housing

	CRC-400 & rack variants	CRC-400GP & rack variants
<b>General</b>		
Housing type	portable & 19" rack	portable & 19" rack
Extension module slots	8/11/13/17	7/10/12/16/17
Aggregate sampling rate	400 kSps	400 kSps
external imc CRONOSflex moduls (CRFX)		○
aggregate sampling rate (incl. ext. CRFX modules)		2000 kSps
<b>Operating conditions</b>		
Standard operating temp. range	●	●
Extended temp. range (incl. condensation)	○	○
Shock vibration rating	MIL 810F (40g)	
<b>Connectivity</b>		
Ethernet	100 MBit	1 GBit
int. WiFi adapter IEEE 802.11.g (54 Mbit/s)	○	○
Dual Band IEEE 902.11.g (300 Mbit/s)		○
GPS connection port	●	●
Display connection port	●	●
Remote controlled main switch	●	●
Programmable status feedback (LEDs)	●	●
<b>Data storage</b>		
CF card slot (Compact Flash)	●	
Storage on PC / network drive (NAS)	●	●
CFast, USB host	400GP	
SSD (internal)	○	○
<b>Stand-alone capabilities</b>		
PC independent complex trigger functionality	●	●
Onboard real-time data analysis (imc Online FAMOS)	●	●
Autarkic PC-less operation, self start	●	●
<b>Synchronization &amp; clock</b>		
Master-slave between different imc systems	●	●
NTP network based synchronization	●	●
PTP network synchronization (precision)		●
Via external GPS signal	●	●
Via external IRIG-B & DCF-77 signal	●	●
<b>Field bus extensions</b>		
CAN, CAN FD	○	○
LIN	○	○
FlexRay	○	○
MVB, IPTCom	○	○
ARINC	○	○
XCPoE (Master, Slave)	○	○
EtherCAT Slave	○	○
<b>Power supply</b>		
DC input 10V to 50V	●	●
Isolated power supply input	●	●
AC/DC adapter (110 to 230VAC)	●	●
AC input (110 to 230VAC)	for AC RACK	for AC RACK
Data integrity upon power fail	●	●
UPS	●	●
UPS (extended range Li-Ion)	○	○



CRC module with DSUB-15 connectors



CRC module with BNC connectors



CRC module with thermocouple connectors



portable system CRC-400-8



19" subrack system CRC-400-AC-Rack

## imc CRONOScompact analog amplifier modules

module name CRC/xxx	size		connector		speed		voltage mode			current	temp	ICP, supply		bridge mode													
	channels	slots (1 slot = 4 HP)	standard connector	LEMO version available	TEDS	max. sampling rate (per channel)	signal bandwidth (-3dB)	isolated voltage mode	min. voltage range (mV)	voltage up to 10 V	voltage up to 50 / 60 V	voltage up to 1000 V	20 mA internal shunt	20mA shunt plug	Thermocouple (TC)	RTD (PT100)	ICP mode integrated	ICP plug	sensor supply (per channel)	full bridge	half bridge	quarter bridge	DC excitation	AC excitation (CF)	single SENSE	double SENSE	
<b>Voltage measurement</b>																											
LV-16	16	2	DSUB-15		●	20 kHz	6.6 kHz		250	●			●				○	○									
LV3-8	8	1	DSUB-15	○	●	100 kHz	48 kHz		5	●	●		●				○	○									
<b>Voltage &amp; temperature measurement</b>																											
OSC-16	16	2	DSUB-15		●	5 Hz	1 Hz	●	50	●	●		●	●	●			○									
OSC-16-2T	16	2	Thermo			5 Hz	1 Hz	●						●	●												
C-8	8	1	DSUB-15		●	20 kHz	20 Hz		2.5	●	●		●	●	●			○									
C8-2T	8	1	Thermo			20 kHz	20 Hz							●	●												
ISO2-8	8	1	DSUB-15	○	●	100 kHz	11 kHz	●	50	●	●		●	●	●		○	○									
ISO2-8-2T	8	1	Thermo			100 kHz	1 kHz	●						●	●												
ISO2-8-L	8	2	LEMO.1B		●	100 kHz	11 kHz	●	50	●	●	●		●	●			○									
ISOF-8	8	1	DSUB-15	○	●	100 kHz	48 kHz	●	50	●	●		●	●	●		○	○									
<b>High voltage measurement 600V CAT III</b>																											
HV2-4U	4	2	Banana			100 kHz	48 kHz	●	2,500	●	●	●															
HV2-2U2I	4	2	Banana / Terminal blocks		●	100 kHz	48 kHz	●	2,500/50	●	●																
<b>Audio &amp; vibration measurements</b>																											
ICPU2-8	8	2	BNC		●	100 kHz	48 kHz		5	●	●					●											
ICPU-16	16	4	BNC		●	20 kHz	6.6 kHz		250	●						●											
<b>Bridge &amp; strain gauge measurements</b>																											
BR2-4	4	1	DSUB-15		●	20 kHz	8.6 kHz		5	●	●		●				○	(●)		●	●	●	●	●	●	●	●
B-8	8	2	DSUB-15	○	●	100 kHz	48 kHz		5	●	●		●	●			○	●		●	●	●	●	●	●	●	●
BC-8	8	1	DSUB-26-HD			100 kHz	48 kHz		5	●	●		●	●						●	●	●	●	●	●	●	●
DCB2-8	8	2	DSUB-15	○	●	100 kHz	5 kHz		5	●	●		●	●			○	●		●	●	●	●	●	●	●	●
DCBC2-8	8	1	DSUB-26-HD			100 kHz	5 kHz		5	●	●		●	●					●	●	●	●	●	●	●	●	●
<b>For universal use</b>																											
UNI2-8	8	2	DSUB-15	○	●	100 kHz	48 kHz		5	●	●	●	●	●	●		○	●		●	●	●	●	●	●	●	●
UNI-4	4	1	DSUB-15	○	●	100 kHz	48 kHz	●	2.5	●	●	●	●	●	●		○	●	●	●	●	●	●	●	●	●	●

## imc CRONOScompact DIO, pulse counter, DAC modules

module name	size slots (1 slot = 4 HP)	connector standard connector	digital I/O		DAC		pulse counter			
			input Bits	high voltage	output Bits	high current	analog outputs	counter inputs	quadrature mode chan	counter frequency
<b>Multi functional modules</b>										
DI16-DO8-ENC4	2	DSUB-15	16		8		4	2	32 MHz	
DI8-DO8-ENC4-DAC4	2	DSUB-15	8		8	4	4	2	32 MHz	
<b>Pulse counter modules</b>										
HRENC-4	1	DSUB-15					4	4	256 MHz	●
FRQ-4	1	DSUB-15					4		256 MHz	
<b>Digital I/O modules</b>										
DI2-16	1	DSUB-15	16							
DO-16	1	DSUB-15			16					
DO-16-HC	1	DSUB-15			16	●				
DIO-HV-4 (250V)	2	Terminals	4	●	4	●				
<b>Analog out modules (DAC)</b>										
DAC-8	1	DSUB-15				8				
<b>Real-time control modules (PID, simulation, custom solutions)</b>										
SYNTH-8	1	8 independent PID controller, arbitrary signal generator (synthesizer)								
APP-MOD	1	custom programmable real-time applications, HW-interface integrations								

Key: ● Default, ○ Optional, (●) Restricted

### TEDS support

(Transducer Electronic Data Sheet)  
imc CRONOScompact modules support direct read/write of TEDS sensors, including imc's TEDS Clip. TEDS interfaces require either the ACC/DSUB-TEDS-x variants of our connectors (2-wire TEDS), or per-channel connectors such as Lemo. „IEPE“ type TEDS is supported in direct IEPE/ICP input modules.

### Digital I/O

galvanically isolated, configurable to 24V/5V (TTL/CMOS) Level, output: 0.7A sink, high current: sink and source 0.7A

### Pulse Counter

full analog input conditioning  
500 kHz analog bandwidth, differential input, analog filter, software adjustable threshold levels

Modes: event counter, event counter, time, frequency, speed, RPM, differential and absolute angle and displacement

# imc CRONOS-XT

## Rugged Data Acquisition System

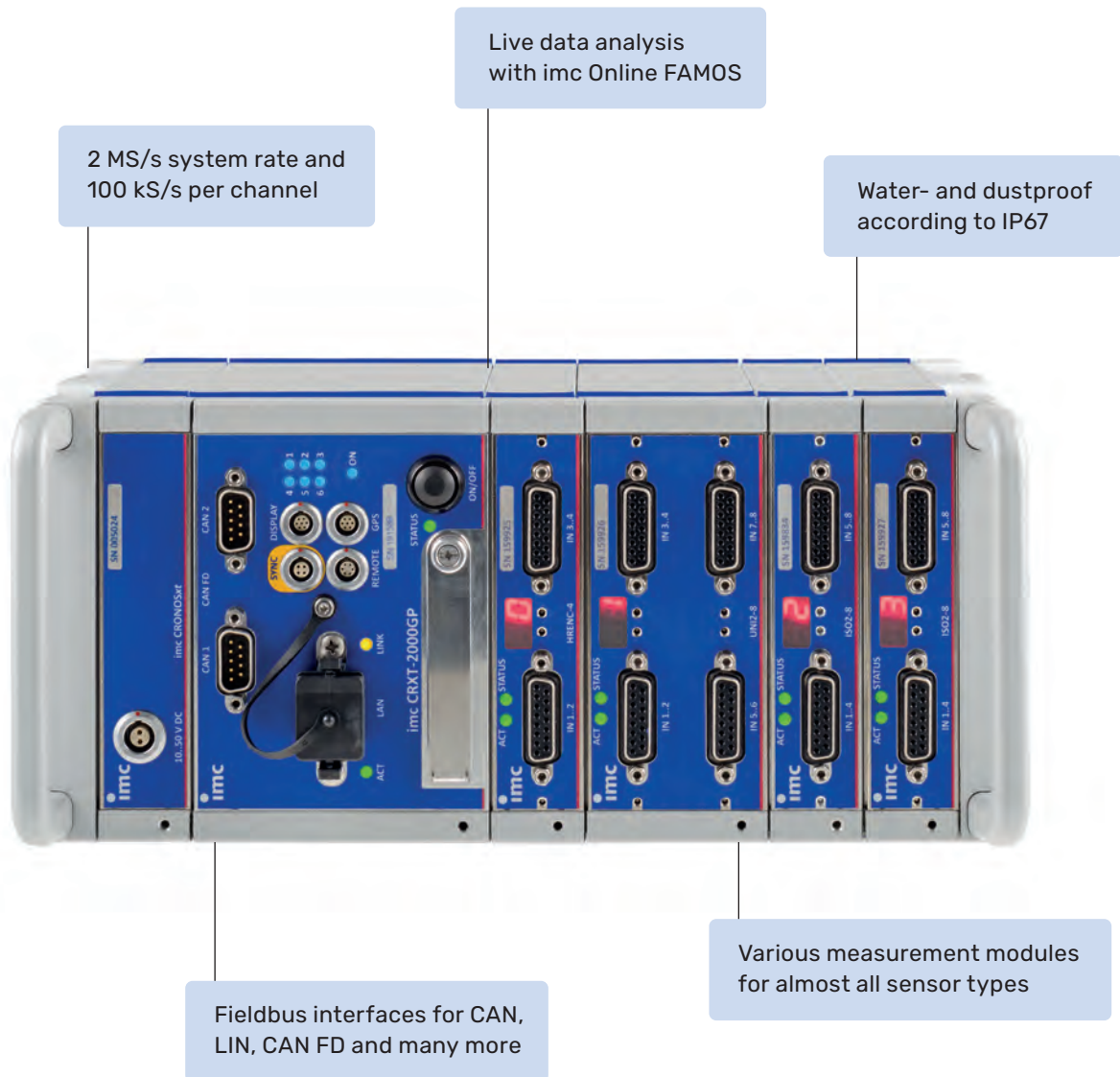

No more compromises: With the imc CRONOS-XT, imc is offering an **ULTRA-ROBUST DAQ** system in a configurable platform. Customize your data acquisition system to your needs. In addition to the base unit (data logger), you can choose from numerous universal and specialized precision measuring amplifiers. With protection class **IP67** and **MIL-STD810F**, the system is protected against dirt, dust and water as well as severe shocks and vibrations.

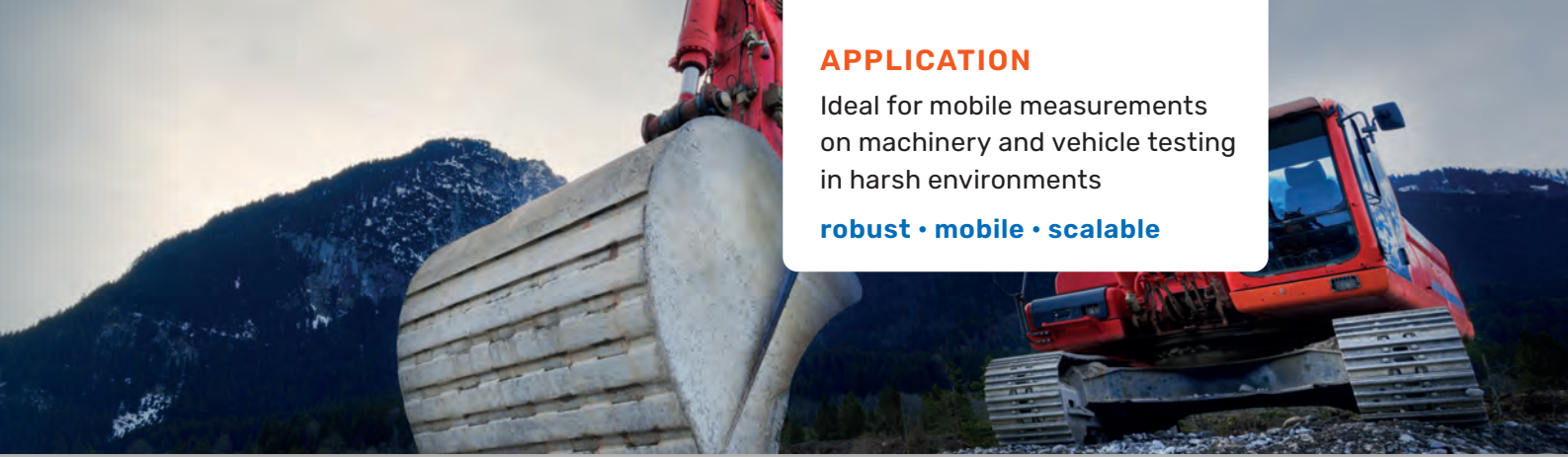

## APPLICATION

Ideal for mobile measurements  
on machinery and vehicle testing  
in harsh environments

**robust • mobile • scalable**

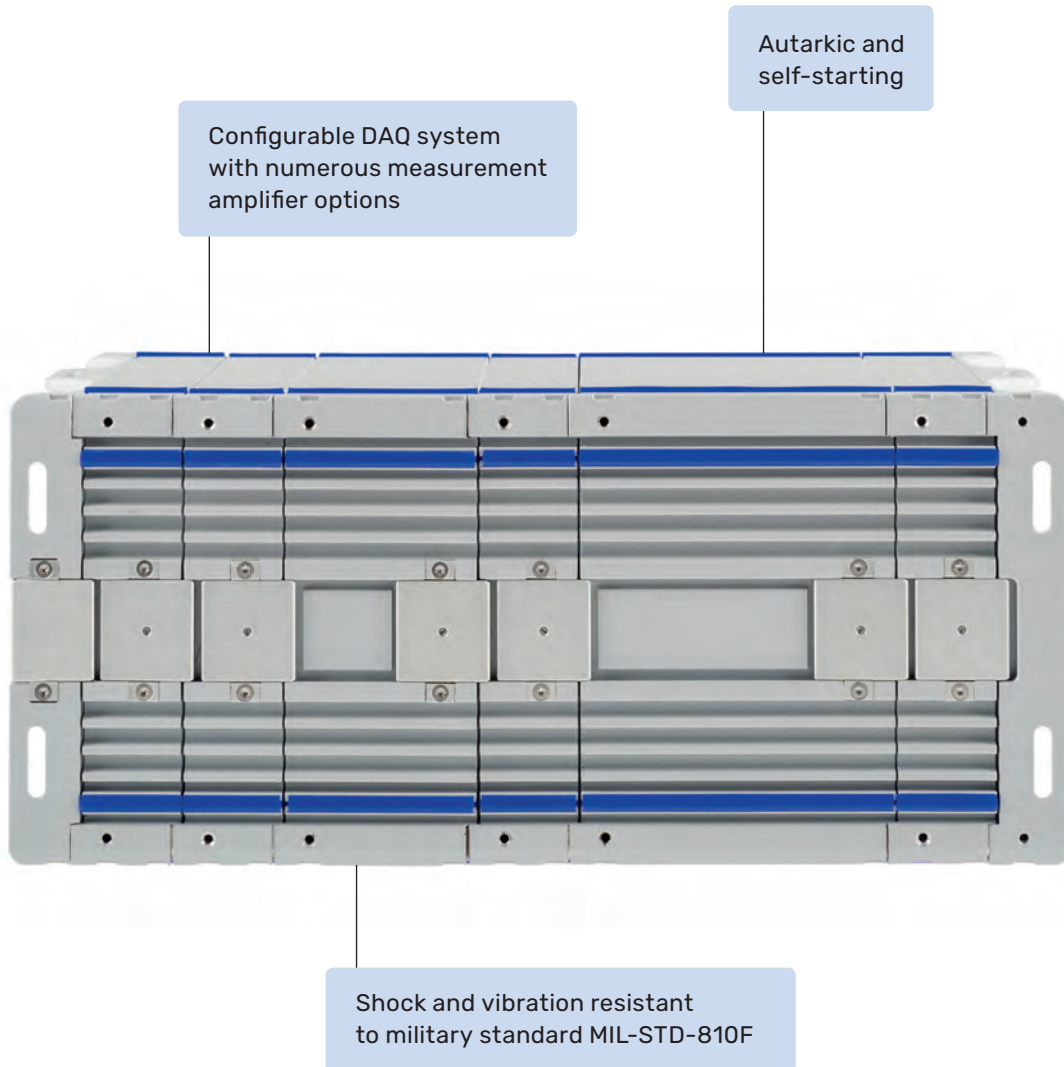

Thanks to the configurable technology, the DAQ system can be ideally adapted to the measurement task at hand. A broad selection of high-precision universal and special measurement amplifiers allow the direct connection of almost all sensor types. The **PRECISE** and low-noise measurement amplifiers digitize with 24 bits and have high bandwidth and range dynamics.

# imc CRONOS XT Details

## Base unit

	CRXT-2000
<b>General</b>	
System sampling rate	2000 kSps
<b>Operating conditions</b>	
Temperature range	-40 .. +85°C
Condensation-proof	●
Shock and vibration	MIL 810F
<b>Connectivity</b>	
Ethernet	1 GBit
Internal Wi-Fi adapter IEEE 802.11.n (300 Mbit/s)	○
EtherCAT connection for distributed CRXT blocks	○
GPS connector	●
imc handheld display	●
Remote control main switch	●
Programmable LEDs for status indication	●
Isolated synchronization signal	●
<b>Data storage</b>	
CFast card slot	●
Storage on PC / network drive (NAS)	●
SSD hard drive (internal)	○
<b>Autonomous device capabilities</b>	
Complex trigger functionality PC-independent	●
Onboard real-time data analysis (imc Online FAMOS)	●
Autarkic operation without PC, self-start (timer, absolute time)	●
<b>Synchronization &amp; clock</b>	
Master-Slave between imc systems	●
NTP and PTP network-based synchronization	●
Via external GPS signal	●
Via external IRIG-B & DCF-77 signal	●
<b>Field bus extensions</b>	
CAN, CAN FD	○
LIN	○
FlexRay	○
MVB, IPTCom	○
Profinet, Profibus	○
Modbus (RTU, TCP)	○
ARINC	○
XCPoE (Master, Slave)	○
EtherCAT Slave	○
<b>XCPoE (Master, Slave)</b>	
EtherCAT Slave	●
AC/DC adapter (110 to 230VAC)	●
Supply of external modules via Power-over-EtherCAT	○
Data integrity in case of power failure	●



Base Unit CRXT-2000



CRXT/POWER



CRXT/HANDLE-R



CRXT/HANDLE-L



CRXT/HRENC-4



CRXT/ICPU2-8



CRXT/DCB2-8



CRXT/DCBC2-8



CRXT/UNI2-8



CRXT/ISO2-8

## Analog amplifier modules

module name CRXT/xxx	size		connector		speed		voltage mode			current	temp	ICP, supply		bridge mode											
	channels	slots	standard connector	TEDS	max. sampling rate (per channel)	signal bandwidth (-3dB)	isolated voltage mode	min. voltage range (mV)	voltage up to 10V	voltage up to 50/60V	20mA internal shunt	20mA shunt plug	thermocouple	PT100	ICP mode integrated	ICP plug	sensor supply (per channel)	full bridge	half bridge	quarter bridge	DC excitation	AC excitation (5 kHz)	single SENSE	double SENSE	
<b>Voltage measurement</b>																									
LV3-8	8	1	DSUB-15	●	100 kHz	48 kHz		5	●	●	●				○	○									
<b>Voltage and temperature</b>																									
IS02-8	8	1	DSUB-15	●	100 kHz	11 kHz	●	50	●	●	●	●	●		○	○									
IS02-8-L	8	2	LEMO.1B	●	100 kHz	11 kHz	●	50	●	●	●		●			○									
IS02-16-2T	16	2	Thermo		100 kHz	1 kHz	●						●												
IS0F-8	8	1	DSUB-15	●	100 kHz	48 kHz	●	50	●	●	●	●	●		○	○									
IS0F-8-L	8	2	LEMO.1B	●	100 kHz	48 kHz	●	50	●	●	●		●			○									
<b>Audio &amp; vibration measurement</b>																									
ICPU2-8	8	2	BNC	●	100 kHz	48 kHz		5	●	●				●											
<b>Bridge and strain gauge measurement</b>																									
BR2-4	4	1	DSUB-15	●	100 kHz	14 kHz		5	●	●	●				○	●		●	●	●	●	●	●	●	●
B-8	8	2	DSUB-15	●	100 kHz	48 kHz		5	●	●	●				○	●		●	●	●	●	●	●	●	●
DCB2-8	8	2	DSUB-15	●	100 kHz	5 kHz		5	●	●	●				○	●		●	●	●	●	●	●	●	●
<b>For universal use</b>																									
UNI2-8	8	2	DSUB-15	●	100 kHz	48 kHz		5	●	●	●	●	●		○	●		●	●	●	●	●	●	●	●
UNI-4	4	1	DSUB-15	●	100 kHz	48 kHz	●	2,5	●	●	●	●	●		○	●	●	●	●	●	●	●	●	●	●

### TEDS-support:

All imc CRONOS-XT amplifiers support TEDS (Transducer Electronic Data Sheet) for automatic sensor recognition and configuration (Plug & Measure functionality). Simply connect the sensor, access TEDS and the channel configuration is ready.

Key: ● standard, ○ optional

## Digital inputs and outputs and counter/encoder inputs

module name CRXT/xxx	size	connector	digital I/O DAC				pulse counter		
			digital input Bits	digital output Bits	analog outputs	counter inputs	quadrature mode chan	counter frequency	analog sin/cos mode
<b>Pulse counter</b>									
HRENC-4	1	DSUB-15				4	4	256 MHz	●
<b>Digital I/O, DAC</b>									
DI2-16	1	DSUB-15	16						
DO-16-HC	1	DSUB-15		16					
DAC-8	1	DSUB-15			8				



Waterproof DSUB connector plug for universal signal connection

**Digital I/O:** The digital inputs and outputs are galvanically isolated and configurable for 24V / 5V (TTL/COMOS) with a maximum output current of 0.7 A.

**Counter:** The counter inputs have full analog input conditioning with 500 kHz analog bandwidth (differential input), analog filter and software adjustable switching thresholds. The supported measurement modes are event counter, time, frequency, speed, rpm, angle and distance.

# imc SPARTAN

## Affordable Multi-Channel Data Acquisition System

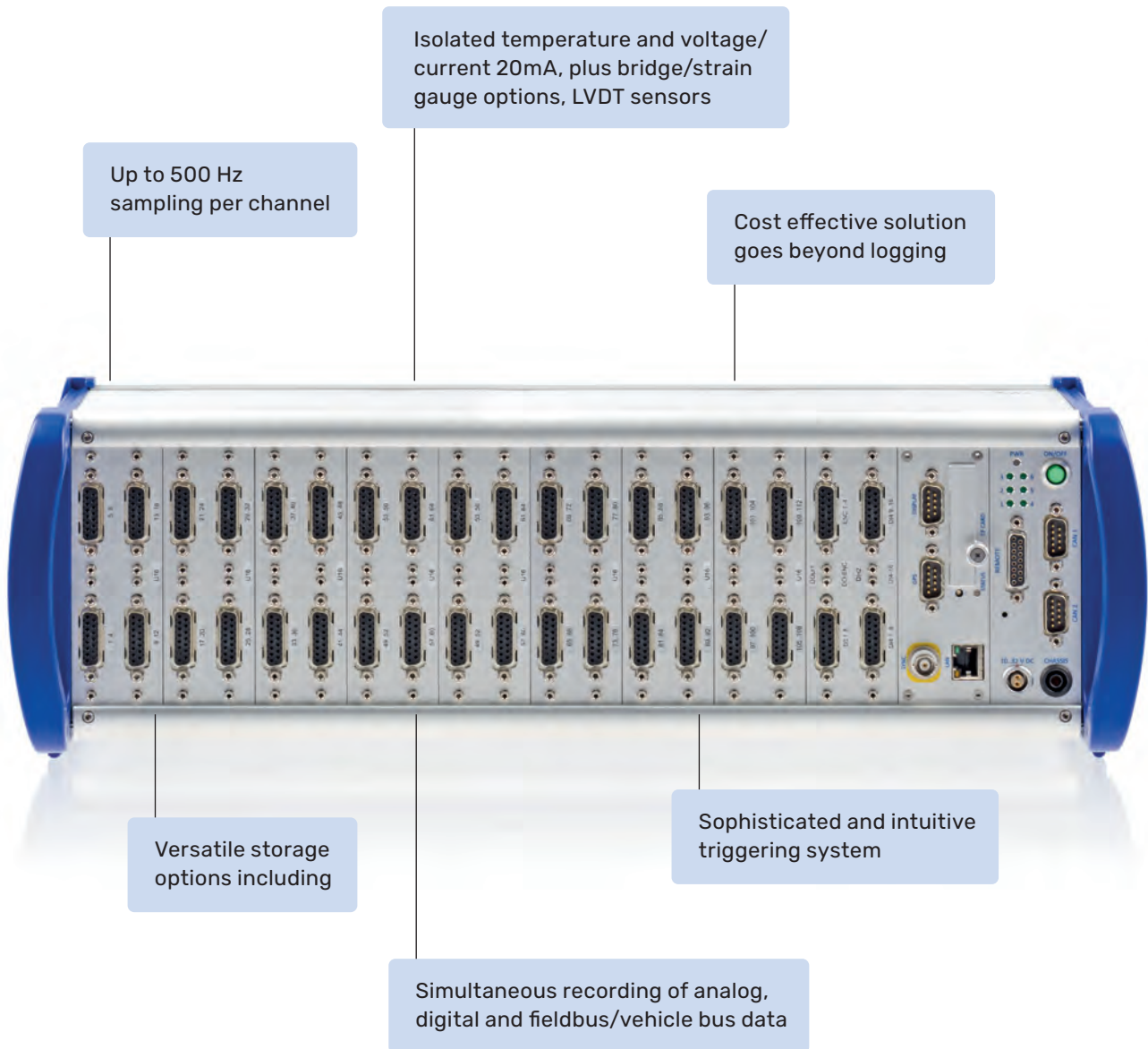

Developed for demanding test applications, imc SPARTAN offers a comprehensive package at surprisingly **LOW PRICE** and even goes far beyond pure data recording. In addition to precision measurement amplifiers with integrated signal conditioning it features multiple sampling rates powerful trigger logic and multiple data storage options as well as an optional real-time computing platform.



## APPLICATION

Ideal for the monitoring tasks, for instance, in civil engineering or transportation applications.

**low-cost • conditioned • capable**

Multiple sample rates and synchronous data processing



Integrated real-time capabilities for analysis, data reduction and control

With up to 500 Samples/second per channel, imc SPARTAN offers a dynamic range, well-suited for most physical and mechanical signals. With **UP TO 128 CHANNELS IN ONE SYSTEM** and the possibility to operate several imc devices cascaded and synchronized in one measurement, imc SPARTAN is the perfect choice especially for **MULTI-CHANNEL APPLICATIONS**.

# imc SPARTAN Details

## imc SPARTAN general specs and housing types

	imc SPARTAN -2 / 4 / 6 / 8	imc SPARTAN -R
<b>General</b>		
Aggregate sampling rate	400 kSps	
Max. channel sampling rate	500 Sps / chan	
Housing type	portable	19" rack
Max. number of channels configurable	32/64/96/128	112 (128)
Configurable module slots (1 slot = 4 HP)	4/8/12/16	14 (16)
<b>Operating conditions</b>		
Standard operating temp. range	●	●
Extended temp. range (incl. condensation)	○	○
Shock and vibration rating	30g pk (3 ms)	
<b>Connectivity</b>		
Ethernet	100 MBit	
W-LAN (WiFi)	○	○
GPS connection port	●	●
Display connection port	●	●
Remote controlled main switch	●	●
Programmable status feedback (LEDs)	●	●
<b>Data storage</b>		
CF card slot (Compact Flash)	●	●
Storage on PC / network drive (NAS)	●	●
SSD (internal)	○	○
<b>Stand-alone capabilities</b>		
PC independent complex trigger functionality	●	●
Onboard real-time data analysis (imc Online FAMOS)	○	○
Autarkic PC-less operation, self start	●	●
<b>Synchronization &amp; clock</b>		
Master-slave between different imc systems	●	●
NTP network based synchronization	●	●
Via external GPS signal, IRIG-B or "DCF-77"	●	●
<b>Pulse counter and process control (digital I/O)</b>		
16 Bit digital in, 8 Bit digital out	●	●
4 pulse counter (2 chan quadrature mode)	●	●
<b>Fieldbus extensions</b>		
Field bus extensions	○	○
CAN, CAN FD	○	○
LIN	○	○
FlexRay	○	○
MVB, IPTCom	○	○
Profinet, Profibus	○	○
Modbus (RTU, TCP)	○	○
ARINC	○	○
XCPoE (Master, Slave)	○	○
EtherCAT Slave	○	○
<b>Power supply</b>		
DC input 10V to 32V	●	●
Isolated power supply input	●	●
AC/DC adaptor (110 to 230VAC)	●	●
Data integrity upon power fail	●	●
UPS	●	●
<b>Software</b>		
imc STUDIO Standard	○	○
imc REMOTE WebServer	○	○



imc SPARTAN-2 with 2 CAN nodes and standard equipment of pulse counter and digital I/O



imc SPARTAN-4



imc SPARTAN-6



imc SPARTAN-8 with 2 CAN nodes and standard equipment of pulse counter and digital I/O



imc SPARTAN module with DSUB-15 connectors



imc SPARTAN module with thermocouple connectors

## imc SPARTAN analog amplifier modules

module name SPAR/xxx	size		connector		speed		voltage mode			mA	temp	ICP, supply		bridge mode								
	channels	slots (1 slot = 4 HP)	standard connector	TEDS	max. sampling rate (per channel)	signal bandwidth (-3dB)	isolated voltage mode	min. voltage range (mV)	voltage up to 10 V	voltage up to 50 / 60 V	20 mA shunt plug	Thermocouple (TC)	RTD (PT100)	ICP plug	sensor supply	full bridge	half bridge	quarter bridge	DC excitation	AC excitation (CF)	single SENSE	double SENSE
<b>Voltage &amp; temperature measurement</b>																						
T16	16	2	DSUB-15	●	5 Hz	1 Hz	●	50	●	●	●	●	●	○								
T16-TC-K	16	2	Thermo		5 Hz	1 Hz	●					●										
T16-TC-UNI	16	2	Thermo		5 Hz	1 Hz	●	50	●	●		●										
U16	16	2	DSUB-15	●	500 Hz	200 Hz	●	50	●	●	●	●	○	○								
U16-TC-K	16	2	Thermo		500 Hz	200 Hz	●					●										
<b>Bridge &amp; strain gauge measurements</b>																						
B16	16	4	DSUB-15	●	500 Hz	200 Hz		5	●	●			○	●	●	●	●	●	●	●	●	●
BC16	16	2	DSUB-26-HD		500 Hz	200 Hz		5	●	●				●	●	●	●	●	●	●	●	●
BCF16	16	4	DSUB-15	●	500 Hz	200 Hz		5	●	●	●		○	●	●	●	●	●	●	●	●	●
LVDT16	16	4	DSUB-15		500 Hz	50 Hz								●	●	●	●	●	●	●	●	●
LVDT16	16	2	DSUB-26-HD		500 Hz	50 Hz								●	●	●	●	●	●	●	●	●

## imc SPARTAN DIO, counter, DAC modules

module name SPAR/xxx	size		connector		digital I/O		DAC	pulse counter		
	slots (1 slot = 4 HP)	standard connector	input Bits	output Bits	analog outputs	counter inputs	quadrature mode chan	counter frequency		
<b>Multi functional modules</b>										
DI16-DO8-ENC4	2	DSUB-15	16	8		4	2	32 MHz		
DI8-DO8-ENC4-DAC4	2	DSUB-15	8	8	4	4	2	32 MHz		
<b>Digital I/O modules</b>										
DI-16	1	DSUB-15	16							
DO-16	1	DSUB-15		16						
<b>Analog out modules (DAC)</b>										
DAC-8	1	DSUB-15			8					

## imc SPARTAN software options

Software product	Features		Licensing	
	Functionality	License model	incl.	
<b>Operating software</b>				
imc STUDIO Standard	Operating software, integrated test & measurement suite	PC	○	
imc STUDIO Professional / Developer	Customized operation, scripting, application development	PC	○	
imc CANSAS	In-situ configuration of imc CANSAS modules		●	
imc SENSORS	Sensor data base	PC	○	
<b>Real-time data analysis</b>				
imc Online FAMOS	Real-time calculations, immediate results	Device	○	
imc Online FAMOS Professional	Real-time control extensions, PID control etc.	Device	○	
imc Online FAMOS Kits	Class counting (fatigue analysis), order tracking	Device	○	
<b>Post processing</b>				
imc FAMOS Reader	Data visualisation	PC	●	
imc FAMOS Standard / Professional / Enterprise	Data visualisation, analysis, reporting, scripting	PC	○	
<b>Remote access</b>				
imc LINK	Remote device access, automatic data transfer	PC	○	
imc REMOTE	Web Server, secure https device access	Device	○	
<b>CAN</b>				
Vector database	Vector database interface	Device	○	
ECU protocols	ECU protocol support (KWP 2000, CCP, OBD-2)	Device	○	
<b>Development</b>				
LabVIEW™ VI's	LabView VI components		●	

### Digital I/O

galvanically isolated, configurable to 24V/5V (TTL/CMOS) Level, output: 0.7A sink current

### Pulse counter

full analog input conditioning: 500 kHz analog bandwidth, differential input, analog filter, software adjustable threshold levels

Modes: event counter, time, frequency, speed, RPM, differential and absolute angle and displacement

### TEDS support

(Transducer Electronic Data Sheet) imc SPARTAN support direct read/write of TEDS sensors, including imc's TEDS Clip.

Connectors: TEDS interfaces require either the ACC/DSUBTEDS-x variants of our connectors

Key: ● Default, ○ Optional

# imc C-SERIES

Handy all-in-one Data Acquisition System

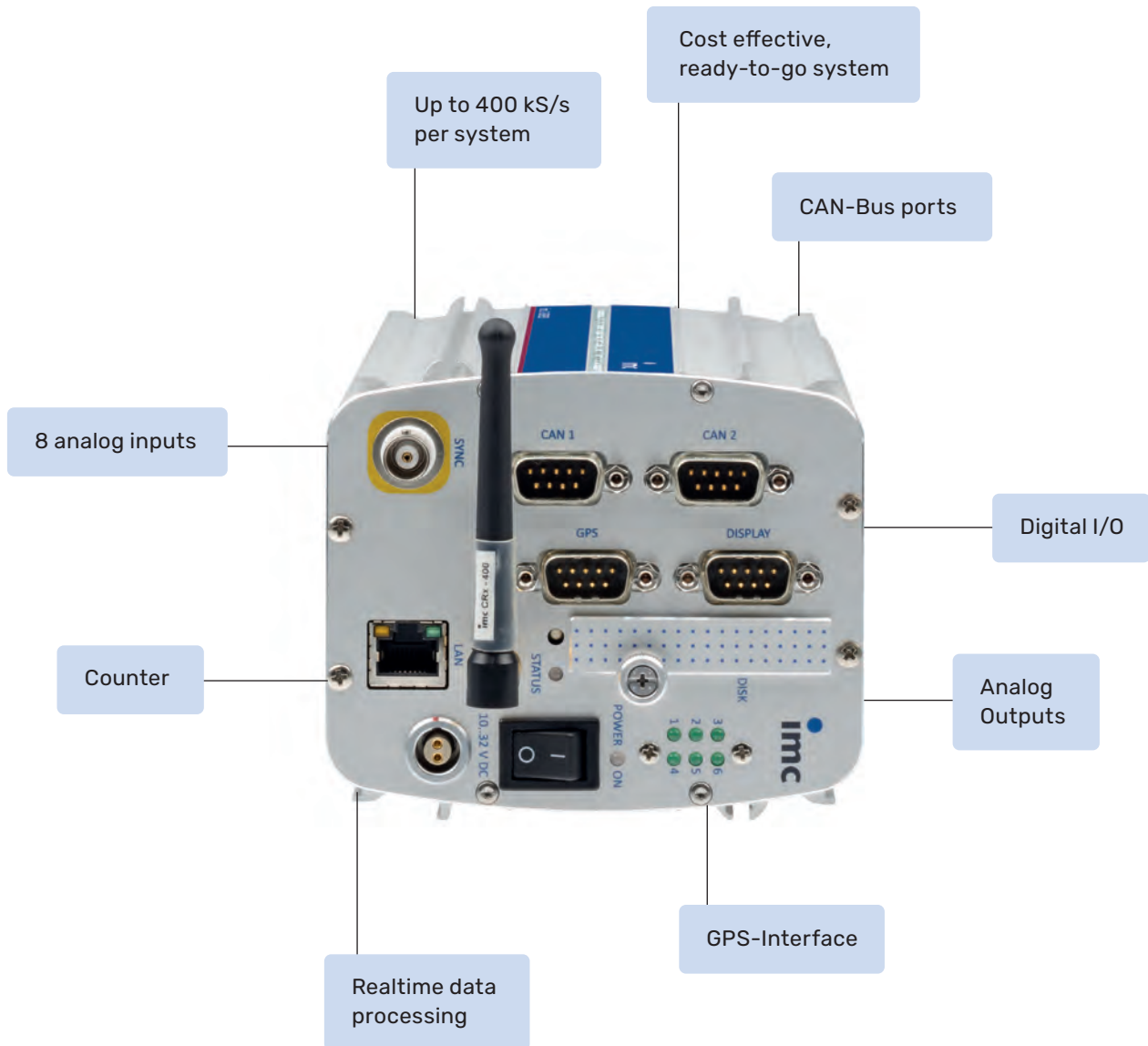

Sized to be **EASILY PORTABLE**, yet surprisingly **VERSATILE**, the imc C-SERIES is also a powerhouse of capability: from the analog inputs with integrated signal conditioning, to the digital I/O, counter inputs, analog outputs and CAN FD interface to the integrated real-time data processing and control platform imc Online FAMOS – everything you need for your test is literally in the palm of your hand!

## APPLICATION

Ideal for the comprehensive test and measurement tasks in test bench and laboratory

**complete • versatile • portable**

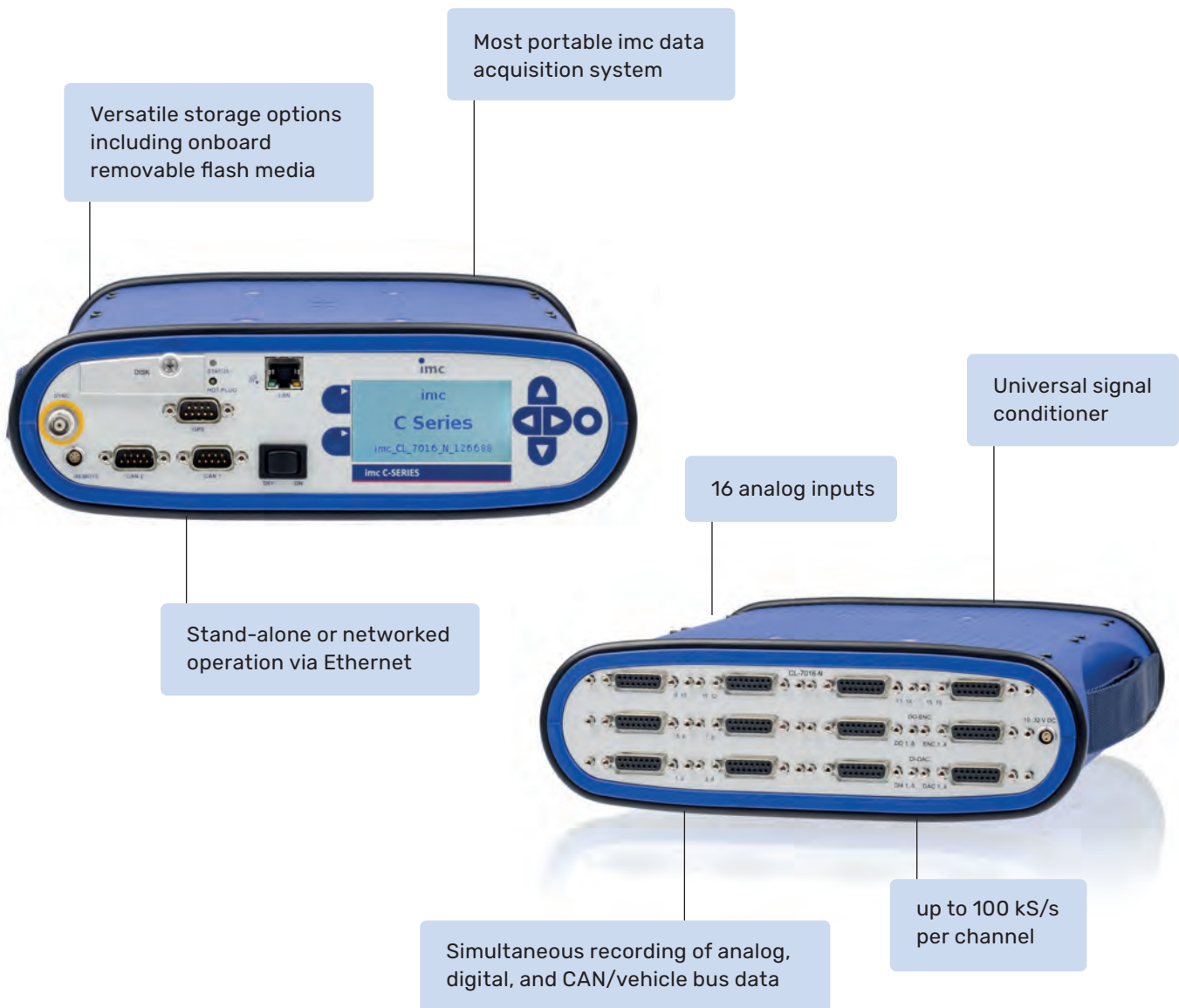

Regardless of where your testing takes you – from the field to the lab – the **ALL-IN-ONE** concept of the imc C-SERIES systems means that you will always have everything you need at your fingertips. And since onboard flash storage gives you the freedom to run interactively or stand-alone, you can easily setup an overnight test and won't have to worry about leaving your laptop behind.

# imc C-SERIES Details

## imc C-SERIES housing types

	CS	CL
<b>General</b>		
Aggregate sampling rate	400 kSps	
Housing type	alu profile	portable polymer
Weight	2 kg	3.5 kg
<b>Operating conditions</b>		
Standard operating temp. range	●	●
Extended temp. range (incl. condensation)	○	○
Shock and vibration rating	MIL 810F (40g)	
<b>Connectivity</b>		
Ethernet	●	●
WLAN (WiFi) internal	○	○
GPS connection port	●	●
Display connection port	●	
Display integrated		●
Remote controlled main switch		●
Synchronization signal (isolated)	BNC	BNC
Programmable status feedback (LEDs)	●	
<b>Data storage</b>		
CF card slot (Compact Flash)	●	●
Storage on PC / network drive (NAS)	●	●
SSD (internal)		○
<b>Stand-alone capabilities</b>		
PC independent complex trigger functionality	●	●
Onboard real-time data analysis (imc Online FAMOS)	●	●
Autarkic PC-less operation, self start	●	●
<b>Synchronization &amp; clock</b>		
Master-Slave between different systems	●	●
NTP network based synchronization	●	●
Via external GPS signal	●	●
Via external IRIG-B & DCF-77 signal	●	●
<b>Field bus extensions</b>		
CAN (2 nodes) incl. CAN FD (max. 8 MBaud)	●	●
<b>Pulse counter and process control (digital I/O, analog out)</b>		
8 bit digital in, 8 bit digital out	●	●
4 pulse counter (2 chan quadrature mode)	●	●
4 channel analog out (DAC)	●	●
<b>Power supply</b>		
DC input 10V to 32V	●	●
AC/DC adaptor (110 to 230VAC)	●	●
Data integrity upon power fail	●	●
Short-term UPS	Supercaps	NiMH
Automatic shutdown after power failure	1 s	30 s
Isolated power supply input		●
<b>Software</b>		
imc STUDIO test & measurement software	○	○
imc REMOTE WebServer	○	○



CS housing: front and backside



CL housing: front and backside

## imc C-SERIES device models analog channels

device name	size		connector		speed		voltage mode		current	temp	ICP, supply		bridge mode						
	housing	channels	connectors	max. sampling rate (per channel)	signal bandwidth (-3dB)	isolated voltage mode	min. voltage range (mV)	voltage up to 10V	voltage up to 50/60V	20mA internal shunt	20mA shunt plug	thermocouple (TC)	RTD (PT100)	ICP mode integrated	ICP plug	sensor supply	full bridge	half bridge	quarter bridge
<b>Voltage measurement</b>			<b>(C<sup>x</sup>-1xxx)</b>																
CS-1016	S	16	DSUB-15	20 kHz	6.6 kHz		250	●			●			○	○				
CS-1208	S	8	DSUB-15	100 kHz	48 kHz		5	●	●		●			○	○				
<b>Voltage &amp; temperature measurement</b>			<b>(C<sup>x</sup>-41xx)</b>																
CS-4108	S	8	DSUB-15	100 kHz	11 kHz	●	50	●	●		●	●	●	○	○				
CL-4124	L	24	DSUB-15	100 kHz	11 kHz	●	50	●	●		●	●	●	○	○				
<b>Audio &amp; vibration</b>			<b>(C<sup>x</sup>-30xx)</b>																
CS-3008	S	8	BNC	100 kHz	48 kHz		5	●	●					●					
<b>Bridge &amp; strain gauge</b>			<b>(C<sup>x</sup>-50xx)</b>																
CS-5008	S	8	DSUB-15	100 kHz	5 kHz		5	●		●	●			○	●	●	●	●	●
CL-5016	L	16	DSUB-15	100 kHz	5 kHz		5	●		●	●			○	●	●	●	●	●
<b>For universal use</b>			<b>(C<sup>x</sup>-70xx)</b>																
CS-7008	S	8	DSUB-15	100 kHz	48 kHz		5	●	●	●	●	●	●	○	●	●	●	●	●
CL-7016	L	16	DSUB-15	100 kHz	48 kHz		5	●	●	●	●	●	●	○	●	●	●	●	●

## imc C-SERIES software options

Software product	Functionality	Licensing	
		License model	included
<b>Operating software</b>			
imc STUDIO Standard	Operating software, integrated test & measurement suite	PC	○
imc STUDIO Professional / Developer	Customized operation, scripting, application development	PC	○
imc SENSORS	Sensor data base	PC	○
<b>Real-time data analysis</b>			
imc Online FAMOS	Real-time calculations, "immediate results"	Device	●
imc Online FAMOS Professional	Real-time control extensions, PID control etc.	Device	○
imc Online FAMOS Kits	Class counting (fatigue analysis), order tracking	Device	○
<b>Post processing</b>			
imc FAMOS Reader	Data visualization	PC	●
imc FAMOS Standard / Professional / Enterprise	Data visualization, analysis, reporting, scripting	PC	○
<b>Remote access</b>			
imc LINK	Remote device access, automatic data transfer	PC	○
imc REMOTE	Web Server, secure https device access	Device	○
<b>CAN</b>			
Vector data base	Vector data base	Device	○
ECU protocols	ECU protocol support (KWP 2000, CCP, OBD-2) for CAN interface	Device	○
<b>Development</b>			
LabVIEW™ VI's	LabVIEW VI components		●
imc API	.net programming interface	PC	○

### TEDS support (Transducer Electronic Data Sheet)

imc C-SERIES supports direct read/write of TEDS sensors, including imc's TEDS Clip.

Connectors: TEDS interfaces require the ACC/DSUB-TEDS-x variants of our connectors. "IEPE" type TEDS is supported in audio modules with direct BNC input connectors.

### Digital I/O

galvanically isolated, configurable to 24V/5V (TTL/CMOS) Level, output: 0.7A sink, high current: sink and source 0.7A

### Pulse counter

full analog input conditioning: 500 kHz analog bandwidth, differential input, analog filter, software adjustable threshold levels

Modes: event counter, time, frequency, speed, RPM, differential and absolute angle and displacement

Key: ● standard, ○ optional



DSUB-15 screw terminal plug



Expansion plug for IEPE/ICP

# imc EOS

## High-Speed Data Acquisition and Transient Recorder



4 MHz sampling rate per channel and device

Able to operate without PC

24 Bit A/D converter

Click connection: mechanically compatible with imc CRONOSflex



Thanks to **HIGH-SPEED DAQ** technology and versatile measurement inputs, imc EOS enables very fast and precise measurements of voltage, current transducers and IEPE sensors for acceleration, sound or force with up to 4 MHz. imc EOS is thus particularly suitable for the analysis of very dynamic processes in blast tests, material and component testing or vibration analysis.



## APPLICATION

Ideal for blasting tests, turbine and rocket tests, through to e-mobility analyses

**fast • precise • versatile**



In automotive applications imc EOS is able to analyze fuel injection and ignition processes, acquire data on high-frequency vibration of motors, transmissions and suspension and investigate switching action and highly dynamic actuators. In the field of e-mobility, the system can be used for characterizing inverter-driven e-motors.

# imc EOS Details

## imc EOS U-4

### General

System data rate	4 MS/s (1x4 MHz, 2x2 MHz, 4x1 MHz)
------------------	------------------------------------

### Analog inputs

Analog inputs (BNC/LEMO)	4
Sampling rate per channel	1 kS/s to 4 MS/s
Analog bandwidth	1,8 MHz
Operation modes	Voltage measurement, AC- and DC coupling IEPE sensors (AC with current feed)
Measurement ranges	$\pm 100$ mV ... $\pm 60$ V (max. 100 V)
Isolation	channel-wise galvanically isolated
Selectable digital filters	200 Hz ... 500 kHz and Automatic Anti-Aliasing-Filter (digital AAF): max. 800 kHz @ 2 MSps/s
Resolution	24 Bit ADC

### Sensor supply (optional)

Output voltage	$\pm 15$ V ... $\pm 2.5$ V
Selectable	channel-wise configurable
Isolation	channel-wise galvanically isolated
Output power	1.5 W/channel, overload and short circuit proof

### Connectivity

Ethernet	1 x GBit-LAN (RJ45)
WLAN (optional)	WLAN adapter (802.11 g/n/ac, 300 Mbit/s)
Synchronization	1 x BNC (IRIG-B)
External Trigger	2 x BNC (IN/OUT)
Action-Button (manual start, trigger, etc.)	●

### Data storage

Onboard Flash memory	480 or 960 GByte
Storage to PC (network streaming)	●
Arbitrary memory depth with pre- and post-trigger	●

### Autonomous operation

Autarkic operation (without PC)	●
Auto data saving upon power failure	●
Trigger function (PC independent)	●

imc EOS U-4	
<b>Synchronization &amp; clock</b>	
Master-Slave between imc systems	●
Network based synchronization: NTP and PTP (in preparation)	●
via external IRIG-B signal	●
<b>Power supply</b>	
DC supply input 10 to 50 V (isolated)	●
AC/DC adapter (110 to 230 VAC)	●
Data integrity (saving) upon power fail	●
Long term UPS (Li-Ion battery)	○
<b>Operating conditions</b>	
Operating temperature range (standard), non-condensating	-10°C to +55°C
Operating temperature range (extended), condensation allowed	-40°C to +85°C (optional)
Shock and vibration	MIL-STD-810 Rail Cargo Vibration Exposure U.S. Highway Truck Vibration Exposure

Key: ● Default, ○ Optional

## Suitable Accessories



### Active and passive handles

Practical handles for clicked-together module blocks



### HANDLE-LI-IO-L

UPS-Solution for imc EOS and imc CRONOSflex



### NET-SWITCH-5

5-Port GBit-Ethernet-Switch with PPT-Synchronization



### SEN-SUPPLY-4

Powerful sensor supply module for current transducers and current clamps

# imc BUSDAQflex

Intelligent Multi-Bus Data Logger



With the imc BUSDAQflex data logger series you can acquire data from all common bus systems of the automotive, railway, aircraft and machine industry. The standard basic configuration of 2 CAN nodes can be extended to 12 nodes for different field and vehicle buses with the larger device variants.

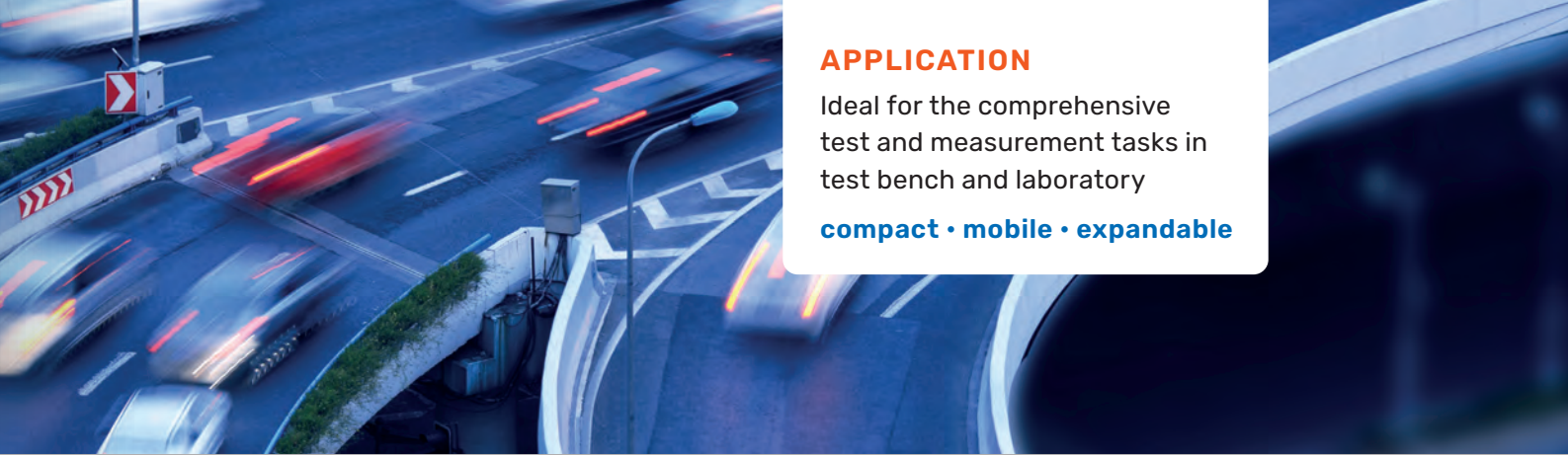

**APPLICATION**

Ideal for the comprehensive test and measurement tasks in test bench and laboratory

**compact • mobile • expandable**

Interfaces for CAN, CAN FD, LIN, FlexRay, J1587, XCPoE, ARINC 429, PROFIBUS, PROFINET, Modbus, MVB

GPS-Interface for synchronous recording of geo position data

Features a CAN module with 2 nodes, extendable by up to 5 fieldbus modules based on housing



Extensive intelligent trigger functions

Sending of CAN messages

Versatile storage options including removable flash media

In addition to the acquisition of raw data streams and protocol channels, the **REAL-TIME DECODING** of individual channels as well as complex protocols such as CCP, KWP2000, XCP, OBD2, etc. are supported. The data logger is perfectly complemented by the imc CANSASflex measurement modules.

# imc BUSDAQflex Details

## General facts & features

	imc BUSLOGflex & imc BUSDAQflex-2S	imc BUSDAQflex-2	imc BUSDAQflex -4,-6,-8,-12
<b>Operating conditions</b>			
Operating temperature	-40 to +85 °C	-40 to +85 °C	-40 to +85 °C
Shock vibration rating (pk over 5 ms)	50 g	50 g	50 g
Protection rating (with opt. protective cover)	IP40	IP40	IP40
<b>Data storage</b>			
Ring buffer memory	●	●	●
SSD (internal)			○
CF card slot (Compact Flash)	●	●	●
<b>Stand-alone capabilities</b>			
Autarkic PC-less operation, self-start	●	●	●
Sleep/Standby, Wake-up-on-CAN	●	●	●
Remote-controllable main switch	●	●	●
Programmable status display (LEDs)		●	●
<b>Synchronization &amp; clock</b>			
Master-slave between different imc systems	●	●	●
Via external GPS signal, IRIG-B or DCF-77	●	●	●
Via external NTP signal	●	●	●
<b>Power supply</b>			
DC input	10 - 50 V DC	10 - 50 V DC	10 - 50 V DC
AC/DC adaptor (110 - 230V AC)	●	●	●
Data integrity upon power failure	●	●	●
UPS (Supercaps)	●	●	●
Power consumption in sleep-mode	200 mW	200 mW	200 mW
<b>Connectivity</b>			
Ethernet (100 MBit)	●	●	●
WiFi adapter internal			○
Wireless UMTS, 3G, 4G (external)	○	○	○

\*1: only with pure CAN/LIN equipment

Key: ● default, ○ optional



imc BUSLOGflex  
imc BUSDAQflex-2-S

imc BUSDAQflex-2

imc BUSDAQflex-4

imc BUSDAQflex-6

imc BUSDAQflex-8

imc BUSDAQflex-12

## Inputs and outputs

	imc BUSLOGflex & imc BUSDAQflex-2S	imc BUSDAQflex-2	imc BUSDAQflex-4,-6,-8,-12
<b>Bus interfaces</b>			
CAN nodes	2	2	2 (max. 12)
Expandable	no	no	yes
<b>Supported expansion modules</b>			
CAN			○
CAN FD			○
LIN			○
FlexRay			○
J1587			○
ARINC			○
XCPoE (Master, Slave)			○
MVB			○
APPMOD (Ethernet/RS232/RS485)			○
<b>Inputs and outputs</b>			
Digital inputs			4
Digital outputs			4
Analog / digital in and outputs (via imc CANSASflex)	○	○	○
<b>Additional connections</b>			
GPS connection		●	●
Display connection		●	●

## Software options

Software product	Functionality	License-model	Included
<b>Operating software</b>			
imc STUDIO Standard <sup>*2</sup>	Operating software, integrated test & measurement suite	PC	○
imc STUDIO Professional / Developer	Customized operation, scripting, application development	PC	○
<b>Real-time data analysis</b>			
imc Online FAMOS	Real-time calculations, immediate results	device	○
imc Online FAMOS Professional	Real-time control functions, PID controller, etc.	device	○
imc Online FAMOS Kits	Class counting (durability analysis), order tracking	device	○
<b>Post Processing</b>			
imc FAMOS Reader	Data visualization	PC	●
imc FAMOS Standard / Professional / Enterprise	Data visualization, analysis, reporting, scripting	PC	○
<b>Remote Access</b>			
imc LINK	Remote device access, automatic data transfer	PC	○
imc REMOTE	Web Server, secure https device access	device	○
<b>CAN</b>			
Vector database	Vector database interface	device	○
ECU protocols	ECU Protocol support for CAN interface (KWP 2000, CCP, XCP, OBD-2, UDS, GMLAN, TP 2.0, DiagOnCAN)	device	○
<b>Applications development</b>			
LabVIEW™ VI's	LabVIEW VI-components		●
imc API	.NET Programmierschnittstelle (API)	PC	○

\*2: not available for imc BUSLOGflex

# imc CANSASflex

Intelligent Measurement Modules based on CAN-Bus

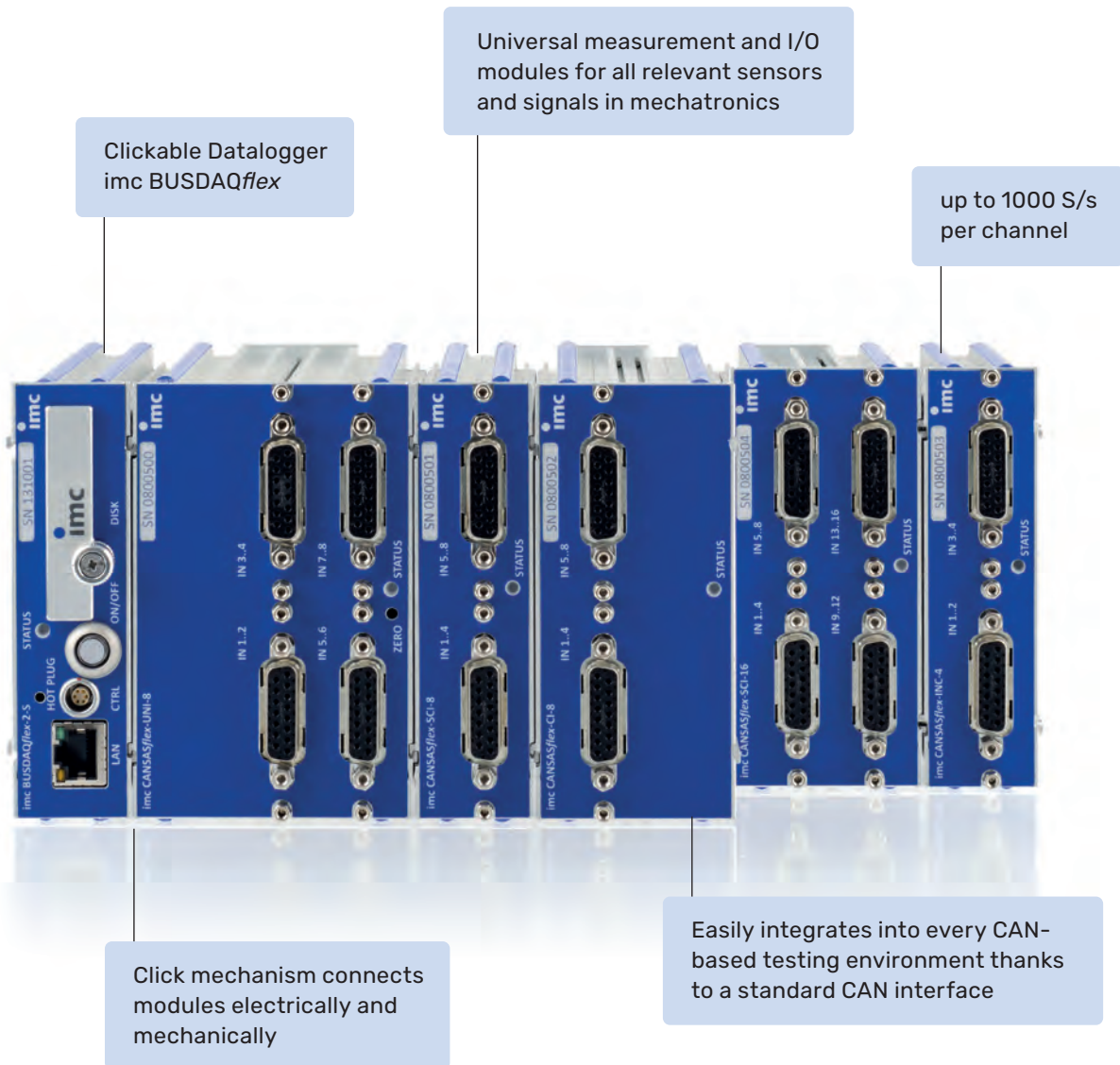

Clickable Datalogger  
imc BUSDAQflex

Universal measurement and I/O  
modules for all relevant sensors  
and signals in mechatronics

up to 1000 S/s  
per channel

Click mechanism connects  
modules electrically and  
mechanically

Easily integrates into every CAN-  
based testing environment thanks  
to a standard CAN interface

The imc CANSASflex series offers a wide selection of can-based DAQ modules, which cover all typical sensors and signals from heavy machinery, industrial installations and vehicles. The modules can be **DISTRIBUTED SPATIALLY VIA CAN** cable or clicked together as a central unit. imc CANSASflex modules are designed to fit into a special 19" subrack solution.

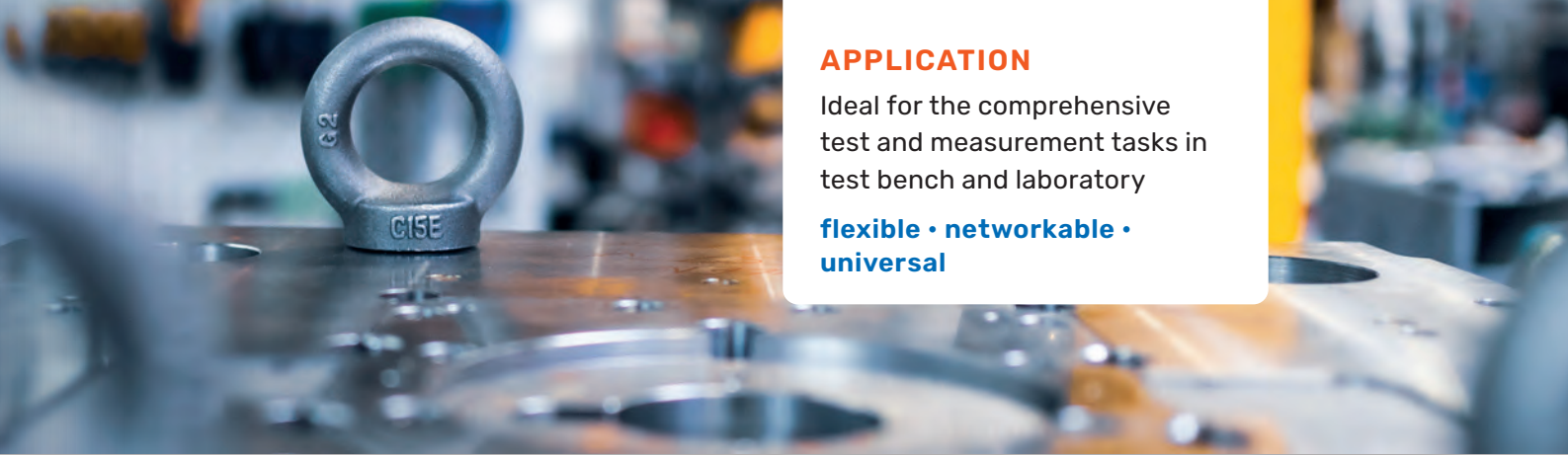

### APPLICATION

Ideal for the comprehensive test and measurement tasks in test bench and laboratory

**flexible • networkable • universal**

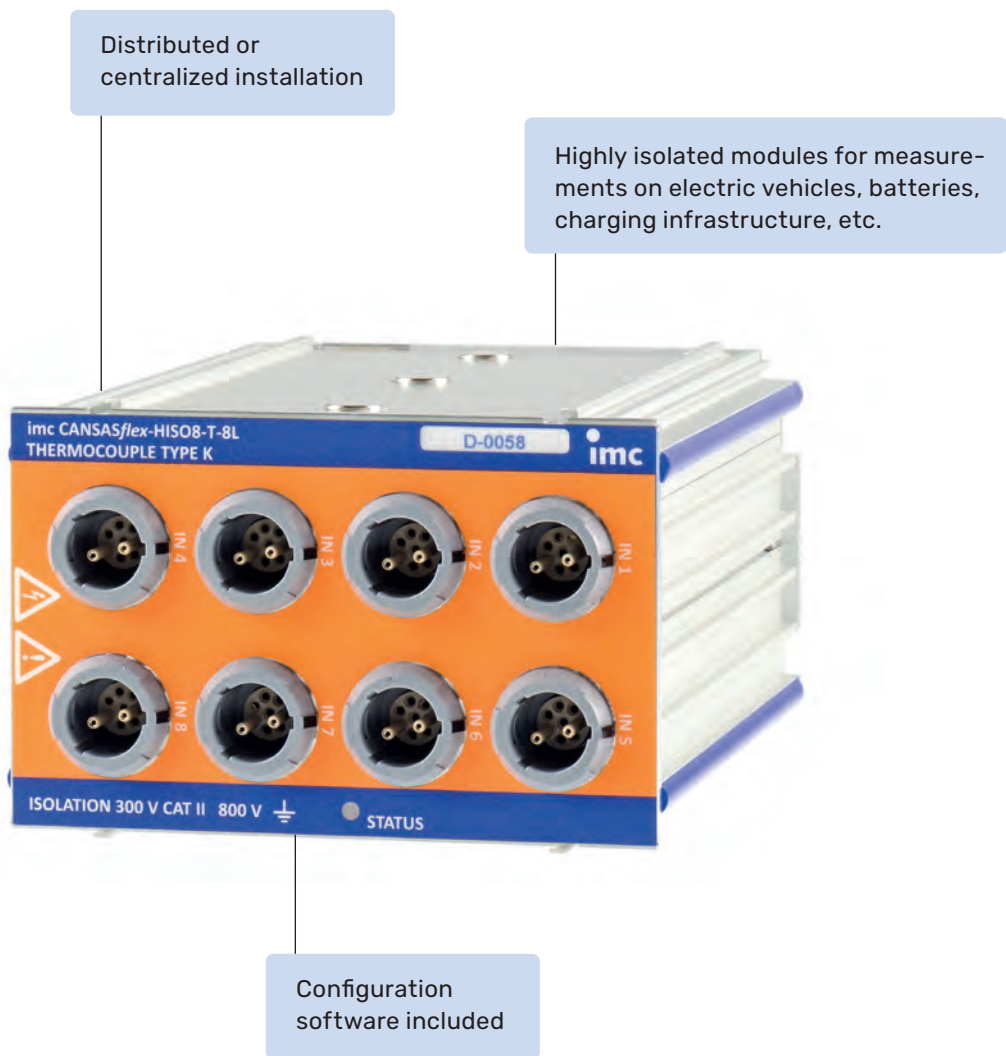

imc CANSASflex offers not only precise and versatile signal conditioning and digitization for CAN based data acquisition but can also deliver immediate results: with virtual channels, calculated directly in the measurement module up to full and comprehensive live analysis with imc Online FAMOS, provided in conjunction with imc CAN loggers such as BUSDAQflex.

# imc CANSASfit

## Robust Measurement Modules

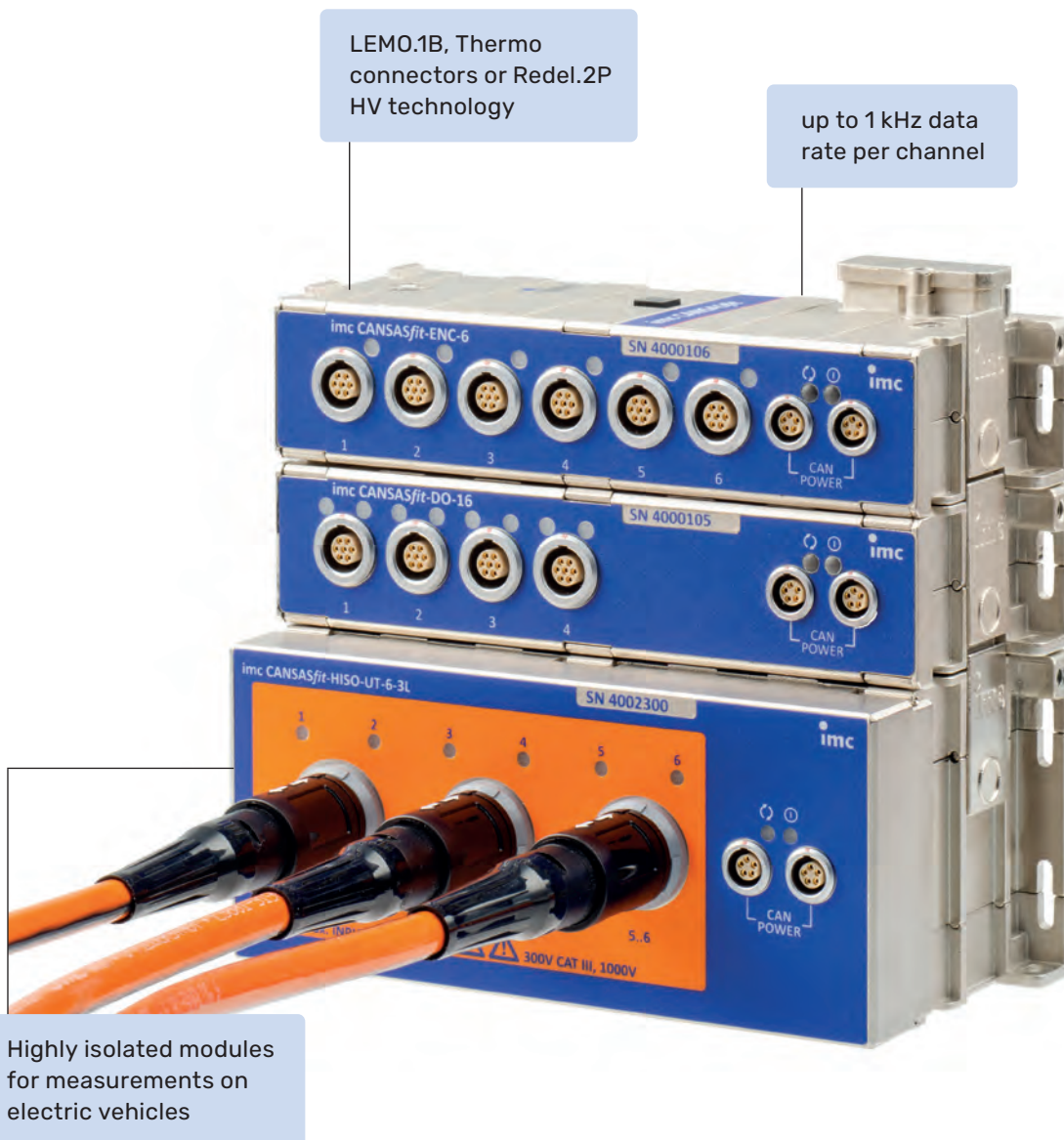

Measurement modules used for DAQ in mobile testing must be **ROBUST** and **COMPACT** because they are often placed in areas such as the engine compartment where space is limited and temperatures can be high. The imc CANSASfit series works reliably from  $-40^{\circ}$  to  $+125^{\circ}$  C, has a protection rating of IP65 and, due to their small form factor, can be placed almost anywhere.

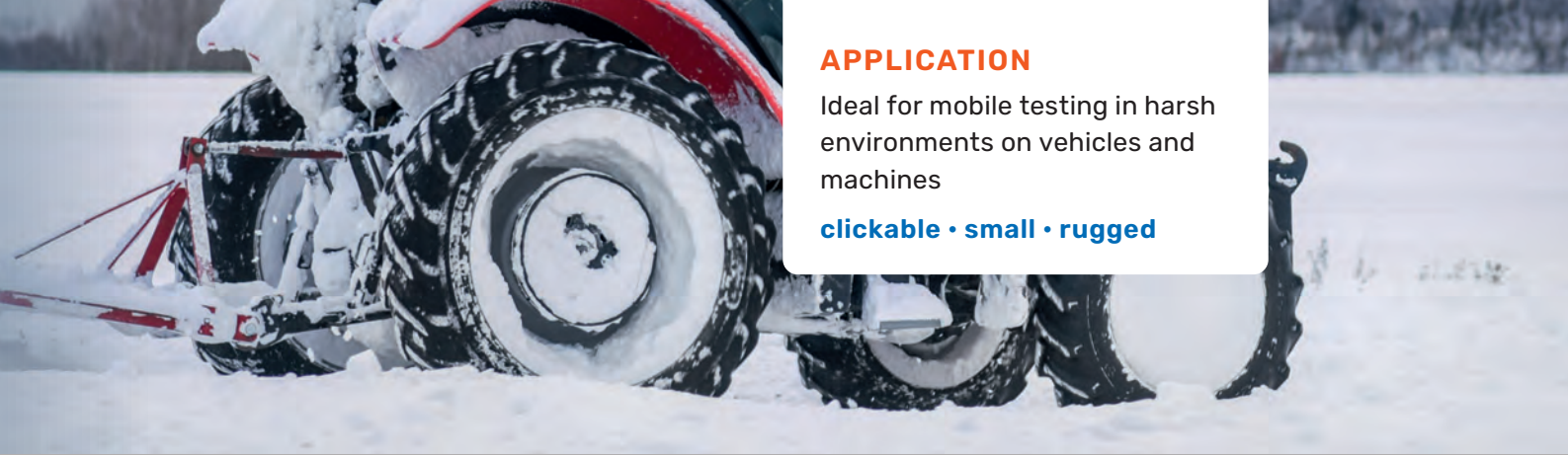

### APPLICATION

Ideal for mobile testing in harsh environments on vehicles and machines

clickable • small • rugged

Robust housing with IP65 protection

Click mechanism - connecting modules without cables or tools

Vibration resistant according to MIL STD-810F

data output to CAN

Operates from -40°C to +125°C

The user can simply click modules together to create blocks. Wiring between the modules is not necessary. The modules allow for direct connection to all typical sensors such as voltage, current, temperature, rpm, displacement and velocity. The digitized signals are output on CAN and can be read or recorded by any datalogger, PC or control system with a CAN interface.

# imc CANSAS family Details

## General specifications and functions

Function		<i>flex</i>	<i>fit</i>
main features		full flexibility universal, special	vehicle tests, „under the hood“
<b>Application</b>			
mobile testing		★★	★★★
test stand		★★★	★
laboratory		★★★	★
mobile machinery		★★	★★★
<b>System</b>			
clickable		●	●
mechanically compatible logger		●	○
19" rack	with slot detection	●	
DIN-rail	mounting kit	●	
CAN terminator	internal, switchable	●	
desktop compatible	rubber buffer	●	
<b>Signal processing</b>			
ADC, processing	24 Bit	●	●
CAN messages	16 Bit integer	●	●
	32 Bit float		●
virtual channels	min/max/mean, linearization math, filter, logic	●	
heartbeat		●	
CANopen		●	
FindMe		●	
configuration read-back		●	
user status LED	freely programmable	●	
<b>Operating conditions</b>			
high temperature		85°C	125°C
sealed		IP40	IP65
shock & vibration resitant	MIL Standard	MIL810	MIL810
DC supply	automotive	10..50 V	7.50 V
	isolated	●	●
<b>Connectors</b>			
I/O connectors	DSUB-15	●	
	LEMO.1B	●	●
	custom (BNC, ITT-Veam...)	●	
CAN + supply	combi socket	DSUB-9	LEMO.0B
supply	separate	LEMO.0B.302	
<b>Portfolio</b>			
diversity	module types	★★★	★
isolation	isolated I/O	★★	★★★
HV modules		●	●
TEDS	plug & measure	●	
temperature		●	●
current, 20 mA		●	●
bridge, strain gauge		●	○
pulse counter		●	●
DI		●	
DO		●	
analog out (DAC, PWM)		●	
RELAIS8		●	
pressure		●	
SENT		●	

Legend: ● standard, ○ optional, (●) limited  
 ★★★ ideally suited ★★ well suited ★ suited



Incremental encoder module:  
imc CANSAS*flex* series



UNI-8 module: imc CANSAS*flex* series



Measurement system with data logger  
imc BUSDAQ*flex* and imc CANSAS*flex*



temperature module of the  
imc CANSAS*fit* series



UTI-6 module of the  
imc CANSAS*fit* series

## Measurement modules: imc CANSASflex / imc CANSASfit

modul name	series			features						connector options					speed		isolation		voltage		current		temp		bridge mode			
	imc CANSASflex (short)	imc CANSASflex (long)	CANFT	channels	TEDS (with DSUB, LEMO)	Sensor Supply	DSUB	LEMO	Thermo	ITT-Veam	Banana	"max. sampling rate (per channel)"	signal bandwidth (-3db)	individually isolated	Isolation Voltage	min. voltage rate (mV)	max. voltage rate (mV)	20mA internal shunt	20mA shunt plug	thermocouple	PT100	PT1000	full bridge	half bridge	quarter bridge (120 Ohm)	quarter bridge (350 Ohm)		
<b>imc CANSASflex modules</b>																												
<b>temperature measurement</b>																												
C8-2T	●			8				●				100 Hz	20 Hz															
CI8-2T	●			8				●				1000 Hz	440 Hz	●	60 V													
SC16-2T	●			16				●				1 Hz	0.5 Hz															
SCI8-2T	●			8				●				2 Hz	1 Hz	●	60 V													
SCI16-2T	●			16				●				1 Hz	0.5 Hz	●	60 V													
<b>voltage and temperature measurement</b>																												
C8	●	●		8	●	○	●	●				100 Hz	20 Hz				2.5 mV			●	●	●						
CI8		●		8	●	○	●	●	●			1000 Hz	440 Hz	●	60 V		20 mV	60 V		●	●	●						
SC16	●	●		16	●	○	●	●				500 Hz	28 Hz				100 mV	10 V		●	●	●						
SCI8	●	●		8	●	○	●	●				1000 Hz	42 Hz	●	60 V		100 mV	60 V		●	●	●						
SCI16	●	●		16	●	○	●	●				500 Hz	23 Hz	●	60 V		100 mV	60 V		●	●	●						
<b>high isolated voltage and temperature measurement</b>																												
HIS08-L		●		8				●				1000 Hz	440 Hz	●	800 V		20 mV	100 V		●		●	●					
HIS08-4L		●		8				●				1000 Hz	440 Hz	●	800 V		20 mV	100 V		●		●	●					
HIS08-T-8L		●		8				●				1000 Hz	440 Hz	●	800 V						●							
HIS08-T-2L		●		8				●				1000 Hz	440 Hz	●	800 V						●							
HIS0-HV4		●		4						●		1000 Hz	440 Hz	●	800 V		10 V	800 V 1000 V (trans.)										
<b>Bridge &amp; strain gauge measurement</b>																												
DCB8		●		8	●	●	●	●				1000 Hz	200 Hz				5 mV	10 V		(●)	●			●	●	●	○	
<b>Universal use</b>																												
UNI8				4	●	●	●	●	●			1000 Hz	200 Hz				5 mV	50 V		(●)	●	●	●	●	●	●	○	
<b>Digital &amp; counter</b>																												
INC4	●			4								1000 Hz	500 kHz															
DI16	●			16								10 kHz																
DO16	●			16								11 kHz																
DO8R	●			8								12 kHz																
DO16R	●			16								13 kHz																
SENT	●			8																								
<b>Analog out &amp; PWM</b>																												
DAC8	●	●		8				●		●		5 kHz	5 kHz															
PWM8	●	●		8				●		●		10 kHz		●														
<b>imc CANSASfit modules</b>																												
<b>voltage and temperature measurement</b>																												
T-10			●	10				●				100 Hz	20 Hz															
UTI-6			●	6		●		●				1000 Hz	400 Hz	●	60 V		25 mV	60 V		●		●	●					
<b>high isolated voltage and temperature measurement</b>																												
HIS0-T-8-2L			●	8				●				100 Hz	15 Hz	●	1000 V CAT I						●							
HIS0-UT-6-3L			●	6		●		●				1000 Hz	400 Hz	●	1000 V CAT I			100 V				●	●					
HIS0-HV-4			●	4						●		1000 Hz	400 Hz	●	1000 V CAT II		25 mV	1500 V										
<b>Digital &amp; counter</b>																												
ENC-6			●	6				●				1000 Hz	2 MHz	●														
DI-16			●	16				●				1000 Hz		●														

TEDS Support (Transducer Electronic Data Sheet)  
imc CANSAS devices support direct read/write of TEDS sensors, including imc's TEDS Clip. TEDS interfaces require either the ACC/DSUB-TEDS-x variants of our connectors (2-wire TEDS), or per-channel connectors such as Lemo or ITT-VEAM.

# imc CANSAS-IHR

## Wide-range Current Measurement Module

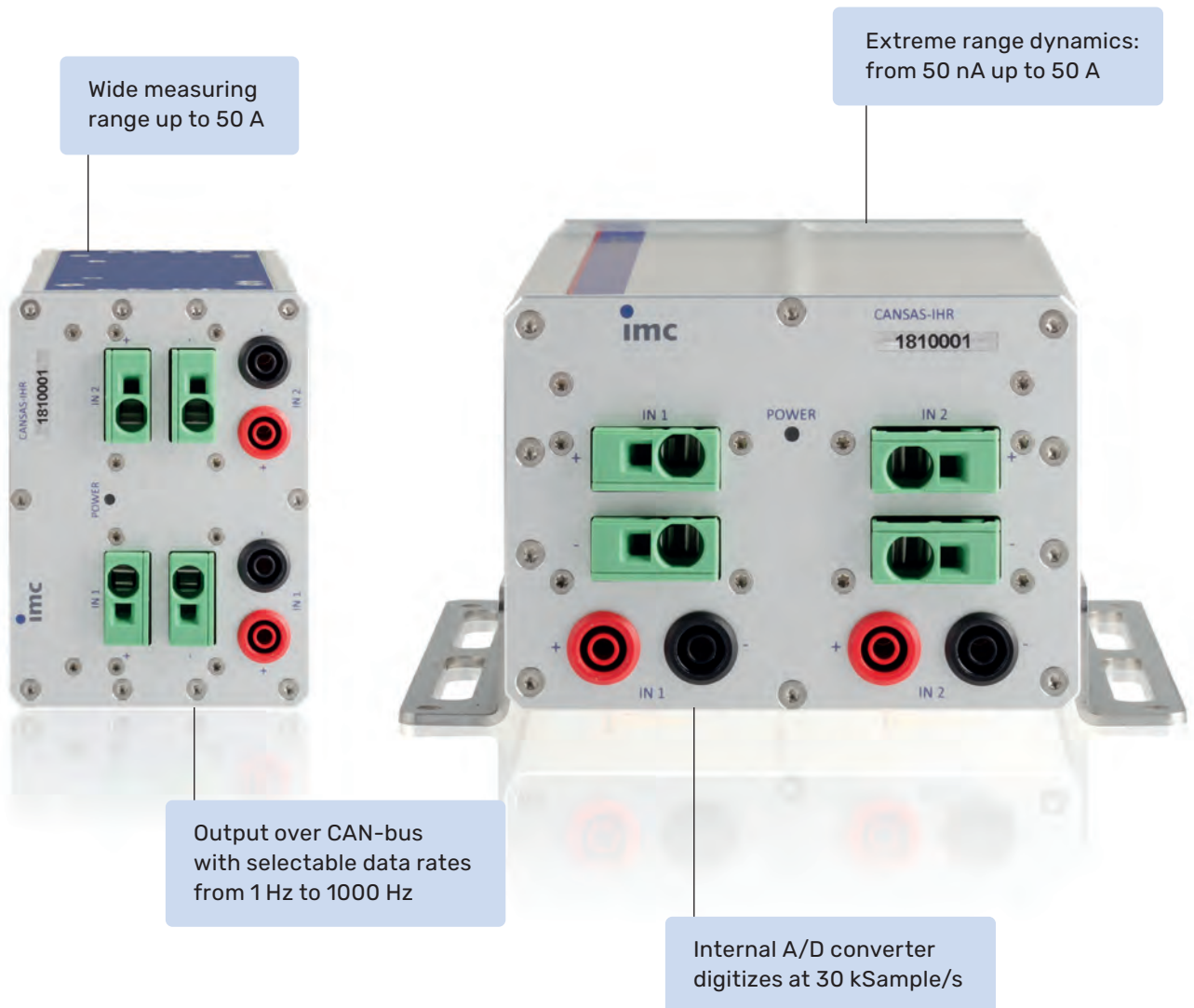

With the imc CANSAS-IHR developers have a unique tool at hand that allows current measurement across a very wide range. When examining quiescent and sleep-mode currents as well as full power loads you can now capture the entire power-up and power-down sequences of electrical components and systems without losing any details – in one single measurement!



### APPLICATION

For continuous measurement of idle current, operating current and sleep modes

**precise • wide range • interruption-free**

Directly calculated output variables: minimum, maximum & mean value

As a rack system for up to 7 plug-in modules with 2 channels

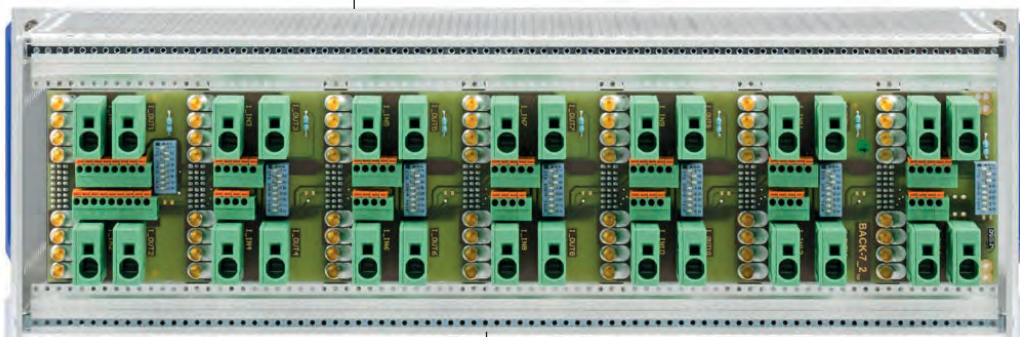
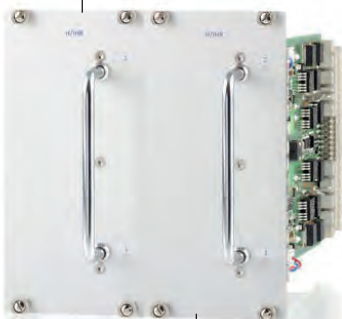

Rack version for laboratory and test stand

Two autonomous, isolated channels for current measurement with automatic range switching

The CANSAS-IHR high resolution measurement module applies auto-ranging by shunt switching, Sophisticated yet plug&play technology supports this high range dynamics in an interruption-free measurement! Capture currents that vary from 50nA to 50A in a single continuous acquisition without interrupting the current path!

# imc STUDIO

Integrated Software for the Entire Testing Process

## CONFIGURE AND MEASURE

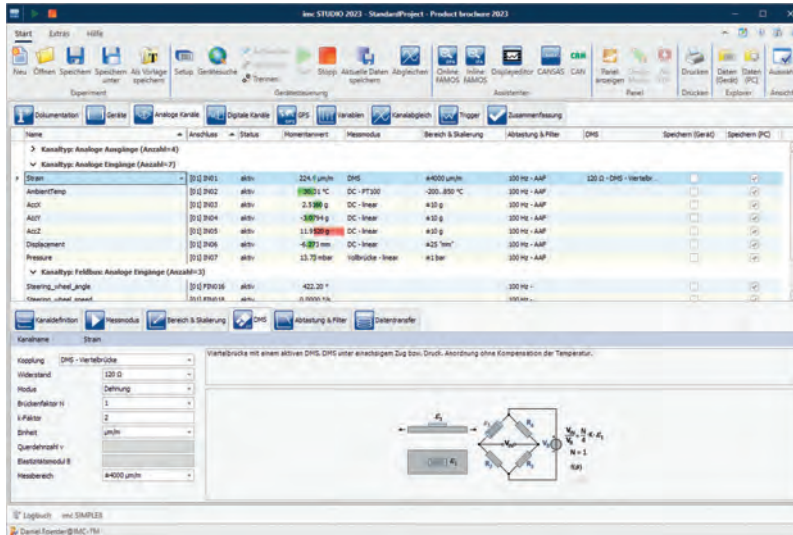

## DISPLAY AND OPERATE



## RECORDING OF VIDEO

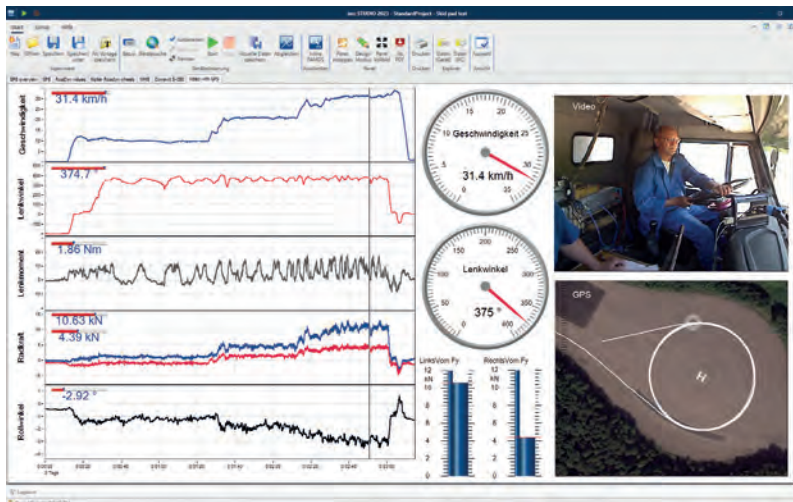

## AUTOMATE TEST STANDS

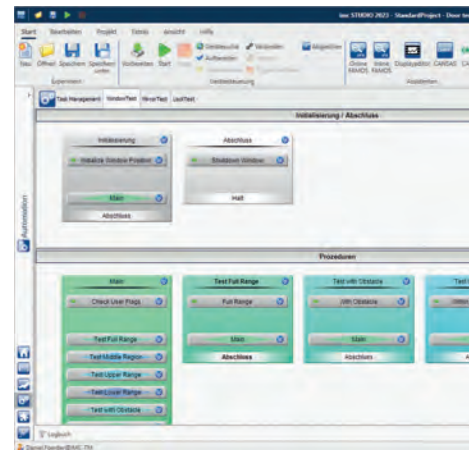

imc STUDIO is a **MODULAR TEST AND MEASUREMENT SOFTWARE** that combines many separate tools in one seamless and integrated environment. Within this framework, users are able to quickly perform measurements, **ANALYZE** data in real-time and create sophisticated tests.

# TEST & MEASUREMENT SOFTWARE

measurement • data analysis  
visualization • automation

## CREATE TEST SEQUENCES

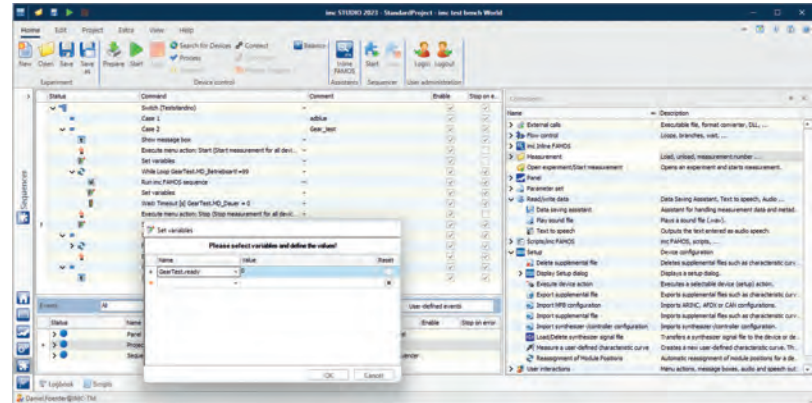
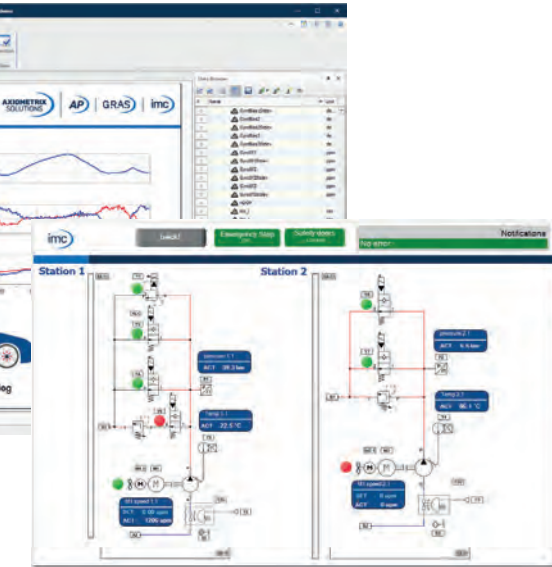

## REAL-TIME ANALYSIS

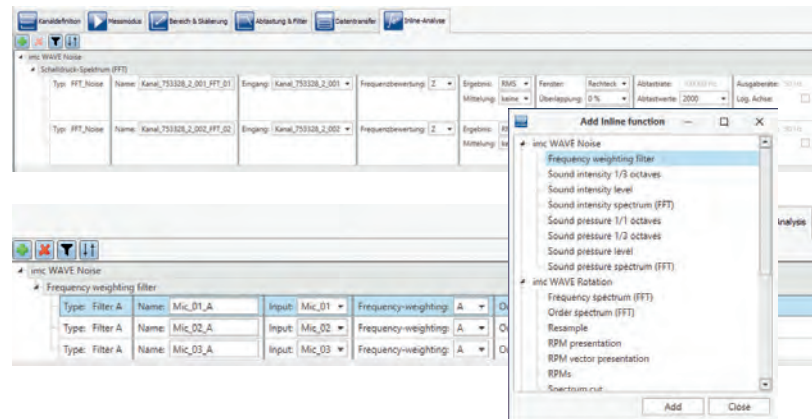
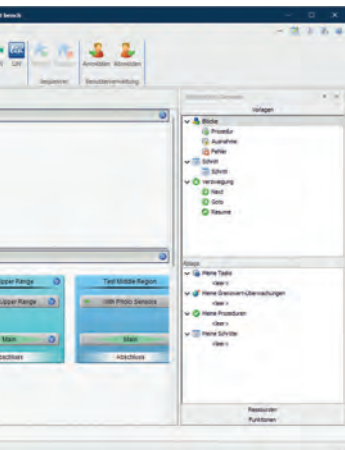

With just a few mouse clicks, you can **SETUP** your DAQ system, **DESIGN** your own screens (Panels), **AUTOMATE** test sequences using drag & drop, **RECORD** GoPro videos and create real-time automation and **CONTROL** for your test bench without programming a single line of code.

# imc FAMOS

## Software for Data Analysis

### IMPORT & EXPORT DATA

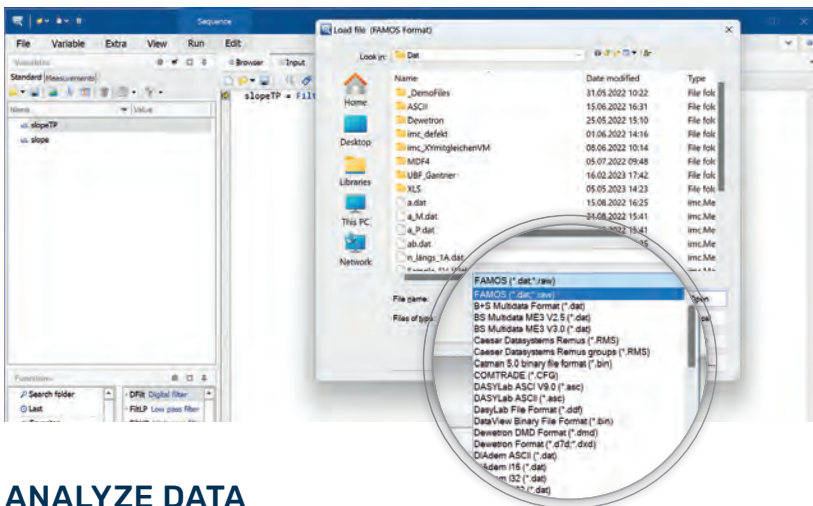

### VIEW DATA

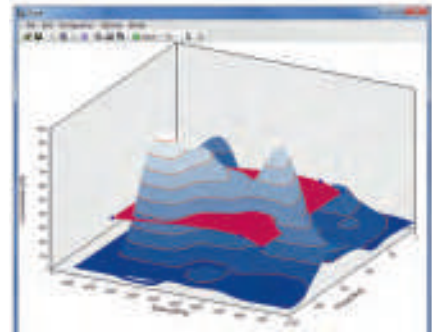

### ANALYZE DATA

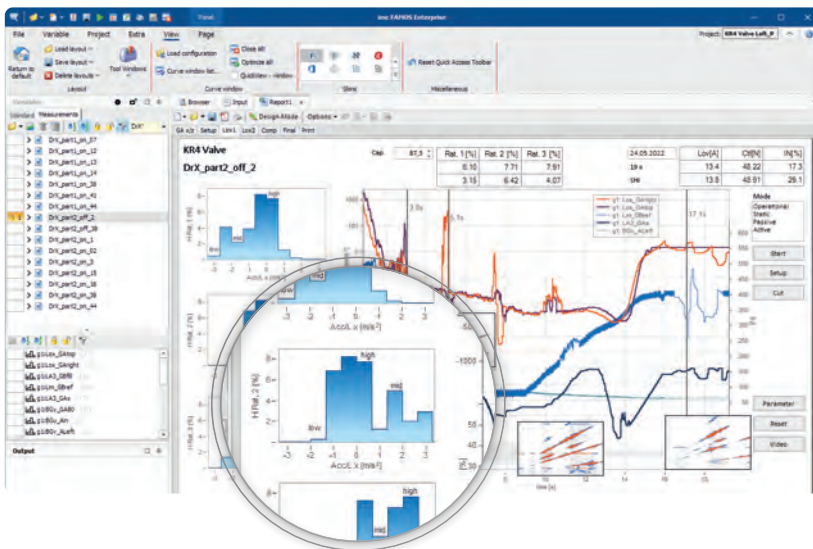

### AUTOMATE

```

1 ; New constants too
2 Data2 = [PI, PI/2, 0, 10*Grad, 10*Rad]
3
4 ; and any expressions / functions
5 Data3 = [1 *V, 2*V, 3, 4, 5]
6
7 Sawtooth = [Ramp(0,1,100), Ramp(0,1,100)]
8
9
10 ; also variables (implicit join)
11 Data_extended = [Data, 0, 0, 0] ; extend with Zeros
12
13 Data_123 = [Data1, Data2[1], Data3]
14 ; Initialization lists can also be placed inside expressions
15 Half_wave = Sin( [0, PI/4, PI/2, 3*PI/4, PI] )
16
17 Data_mean = Mean( [Data1, Data2, Data3] )
18
19
20 Data_xy = xyOf( [Ramp(1,1,100), Ramp(201,1,100)], Sawtooth )
21 ; Matrices, segmented data record with 3 segments of length 2
22 Matrix_3x2 = [[1,2], [3,4], [5,6]] ;
23
24 ; Segmented data record with 2 segments of length 100
25 Matrix_2x100 = [[Ramp(0,1,100)], [Ramp(0,1,100)]]
26
27 ; initializer for text array
28 MainUser = ["Schmidt", "Meier", "Müller"]
29
30 ; extend text array (implicit join)
31 AllUser = [MainUser, "Krause"]
32
33 ; also expressions are allowed
34 Baseline = "channel"
35
36 CompleteLines = [Baseline + "_1", Baseline + "_2", Baseline + "_3"]

```

The **ANALYSIS SOFTWARE** imc FAMOS provides engineers with the versatile tools necessary to visualize and analyze their data, automating routines and complex tasks – from data import to test report. No matter from where your data originates – besides the imc data format, many other data formats are supported and import converters can even be easily customized by the user.

## APPLICATION

For analyzing and reporting of test and measurement data

professional • fast • efficient

## COMPARE DATA

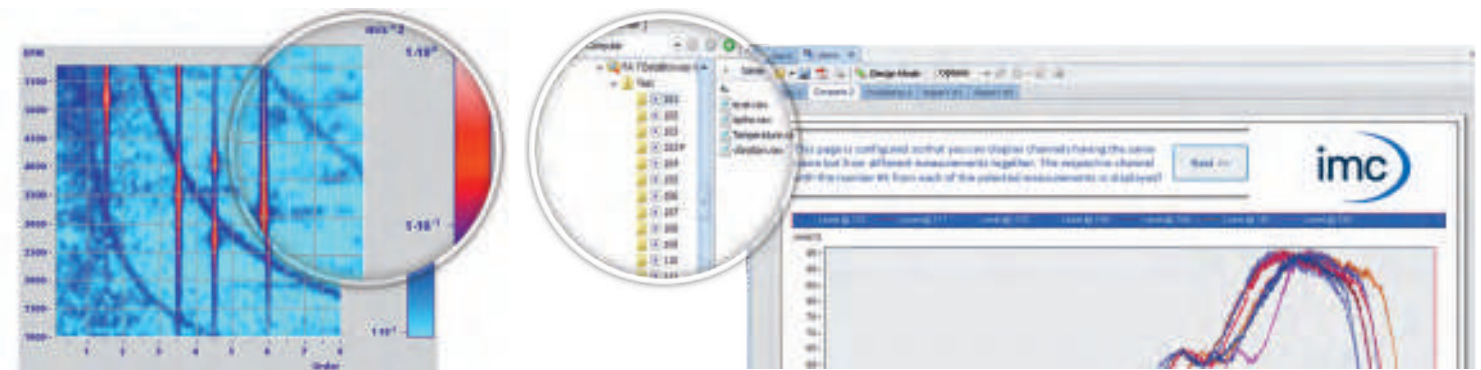

## DOCUMENT

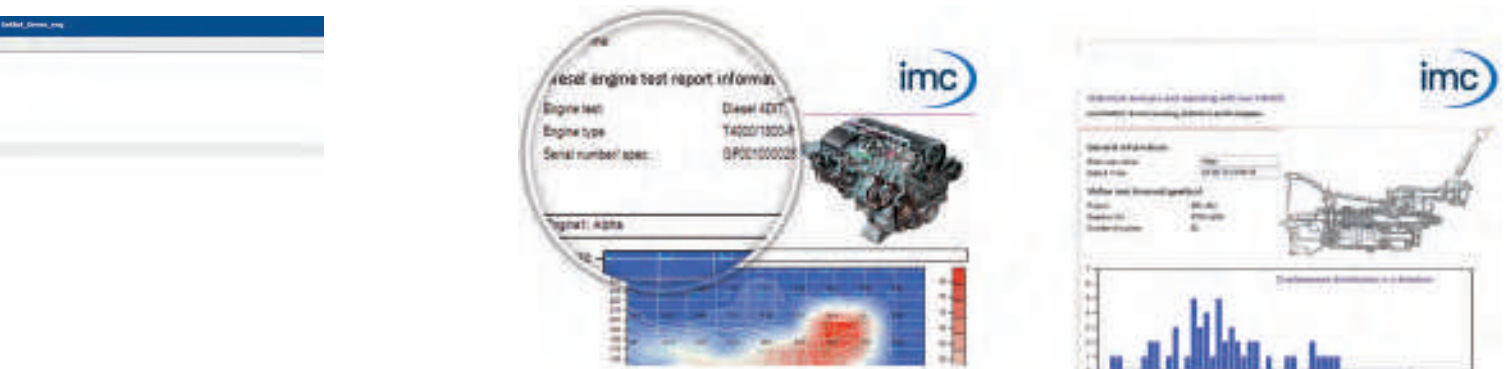

Specifically designed for analyzing test and measurement data, imc FAMOS is ideal for engineers and technicians who wish to solve their analysis tasks more efficiently. With a vast number of analysis functions and powerful automation capabilities, imc FAMOS provides quick results. And with the imc FAMOS Reader, you can quickly and easily view data on every PC, for free.

# imc WAVE

Software for Sound & Vibration Measurement & NVH Analysis

## imc WAVE noise

Measuring sound power and sound pressure

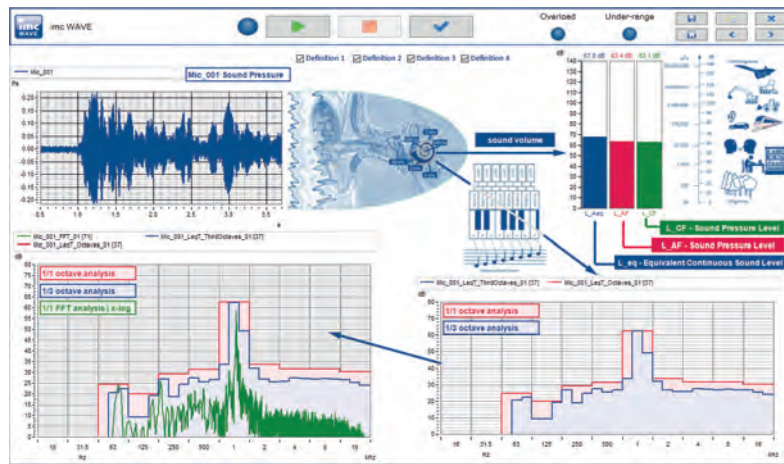

## imc WAVE vibration

Vibration analysis for machine diagnosis & human vibration



imc WAVE is a modular and powerful software platform for **SOUND AND VIBRATION MEASUREMENT** and **NVH ANALYSIS**. With its analyzers you can evaluate a wide range of applications without having to be an expert yourself: From acoustic measurements in road tests to structural analyses on the test bench and vibration tests on machines.

## APPLICATION

The ideal tool for professional NVH analysis

noise • vibration • structure

## imc WAVE rotation

Order analysis on rotating machines

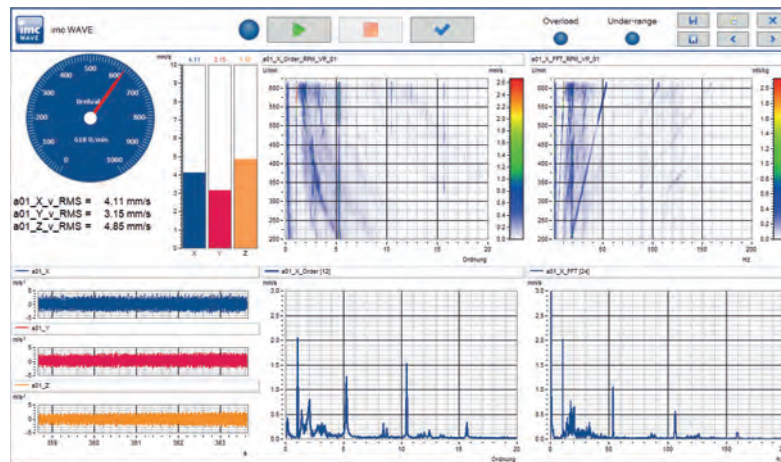

## imc WAVE structure

Structural analysis by impact hammer measurements



The imc WAVE analyzers provide you with **STANDARD-COMPLIANT ANALYSIS** from the fields of sound pressure and sound power analysis, structure analysis as well as vibration analysis on non-rotating and rotating machines. imc WAVE guides you step by step through the settings, from configuration to calibration and measurement. At the end, you receive a professional, print-ready report.

# imc Telemetry Solutions

Digital Telemetry Systems from Single- to Multi-Channel

## TEL1-PCM

12 bit single channel telemetry for strain gauge or thermocouple type K measurement



## TEL1-PCM-FLEX

Bendable single channel telemetry for strain gauge measurement



The TEL1-FLEX is a compact telemetry designed for tight spaces, featuring thin and flexible transmitter electronics for torque measurements in narrow installations. Its pliable film substrate enables effortless application on rotating shafts or machine components.

## T1

16 bit single channel telemetry for strain gauge or PT100 temperature measurement

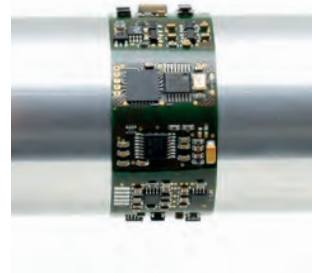

For **MEASUREMENTS ON ROTATING COMPONENTS** and moving machinery, imc offers modern telemetry systems for a wide variety of tasks: whether single-channel torque monitoring of a rotating shaft, multi-channel strain gauge and temperature measurements on a train wheel-set or mechanical power measurement on a vehicle drivetrain in harsh environments. There are telemetry modules available for a large variety of sensors, such as strain gauge, thermocouples, PT100/1000, as well as IEPE sensors and voltage signals. The telemetry systems are characterized by their robust and compact design, digital and interference proof data transmission and their clever supply and installation options.

## APPLICATION

Ideal for the wireless measurement data transmission in machinery, facilities and vehicles

**integrated • flexible • reliable**

## D<sup>x</sup> – Universal telemetry for up to 24 channels

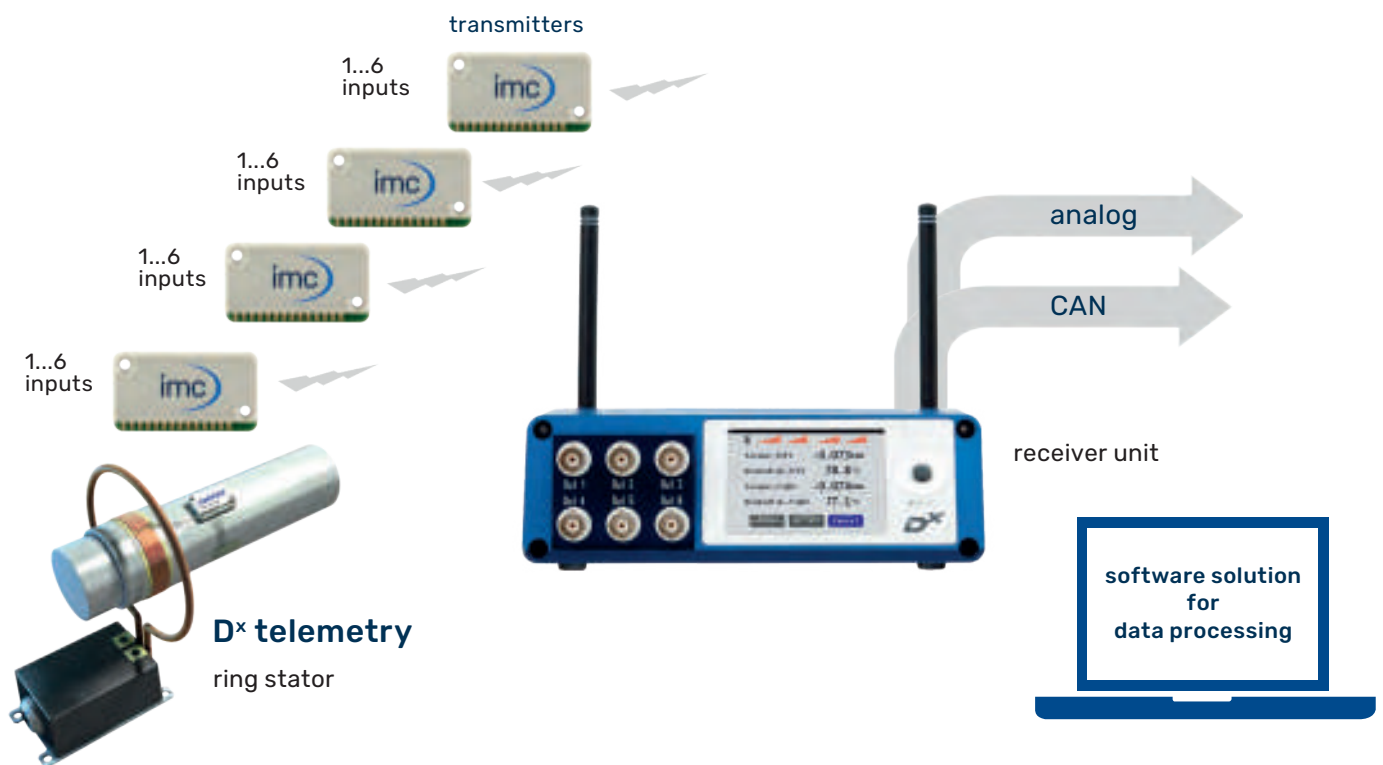

D<sup>x</sup> telemetry is a compact and lightweight **MULTI-CHANNEL TELEMETRY SYSTEM** that enables flexible wireless measurements with varying numbers of channels and sensor assignments. The 14 g transmitter unit supports up to 6 channels and different sensor types, including voltage signals up to +/- 22.5 V, thermocouples and strain gauges in half-bridge and full-bridge circuits. The receiver unit synchronously acquires data via radio transmission from up to 4 transmitter modules, allowing for the simultaneous acquisition and transmission of **UP TO 24 CHANNELS**. Outputs include CAN, and analog interfaces, with easy configuration via Ethernet and a standard web browser.

# imc Modular Telemetry

## Modular Telemetry MTP-NT

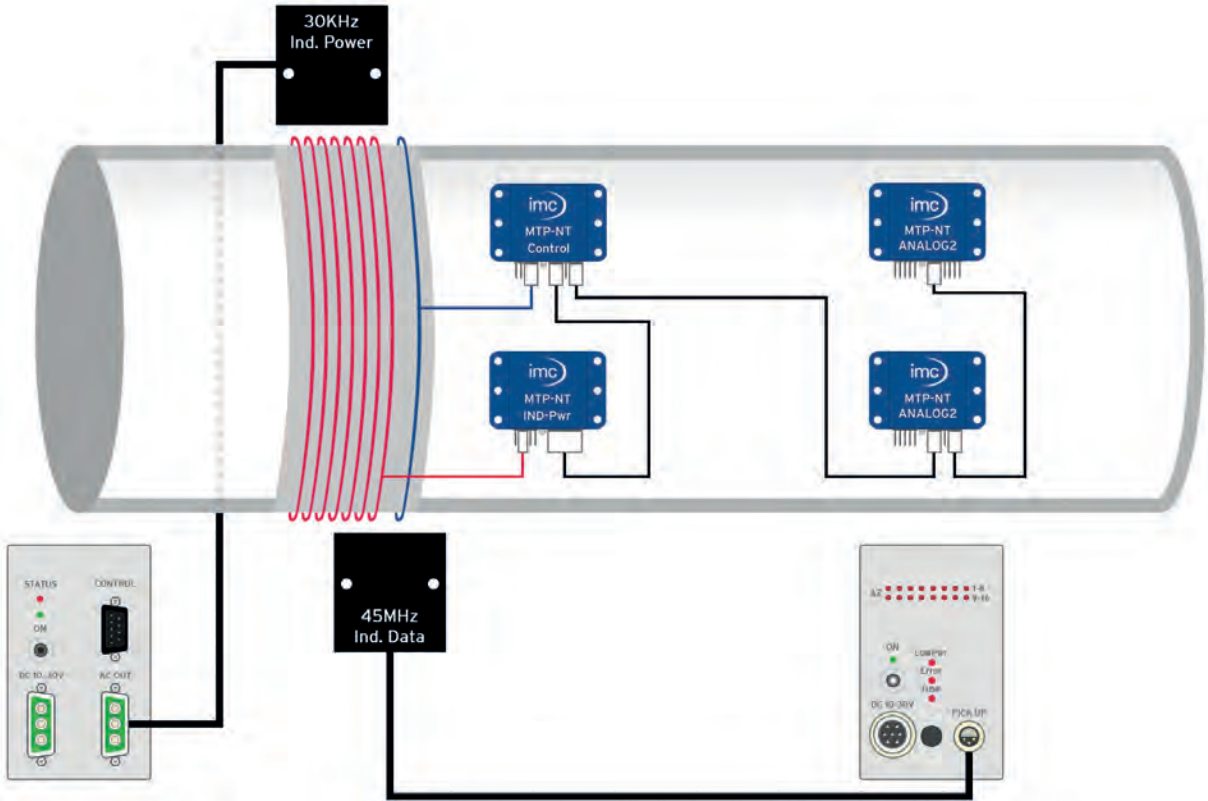

MTP-NT telemetry is a small and **FLEXIBLE TELEMETRY** system that has a modular design. It consists of freely selectable sensor modules, a controller module and an inductive transmitter unit. Depending on the needs of the user, the telemetry system can be freely assembled and subsequently adapted.

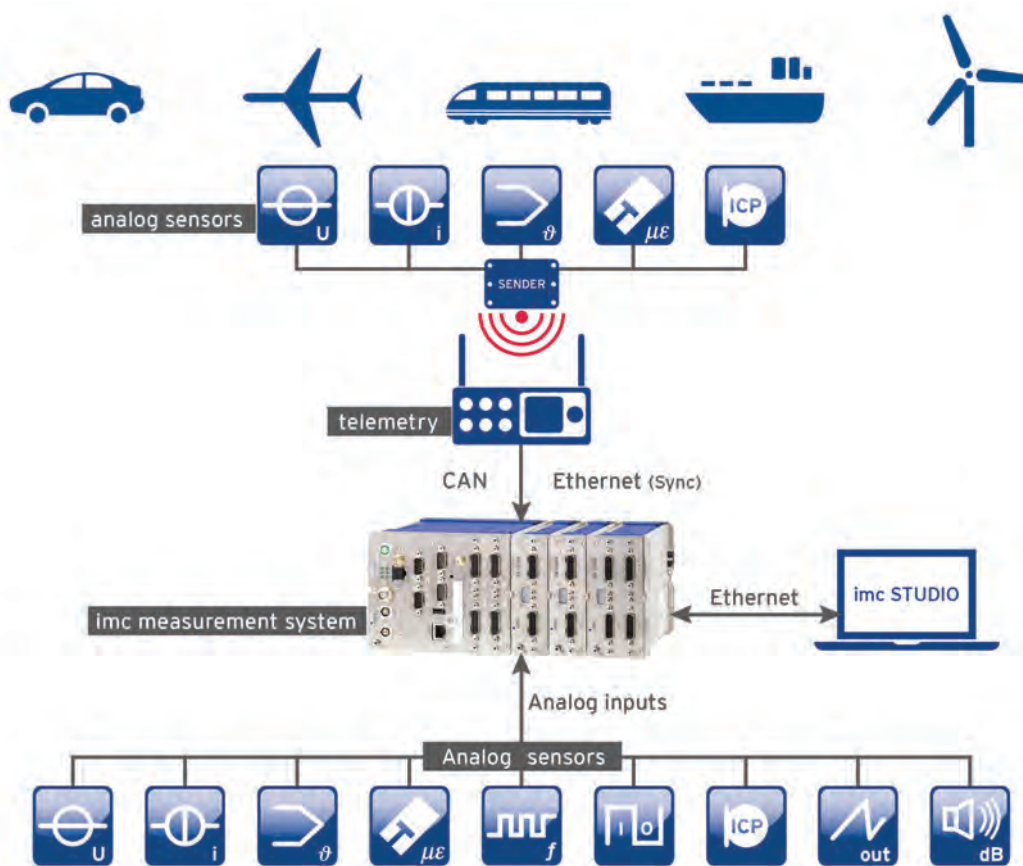

### Variant for Rotor and Propeller Applications

The **CTP-NT-ROTATE** telemetry system enables the acquisition and transmission of 8, 16, 32 or 64 parallel measurement signals from helicopter rotors or aircraft propellers. The integrated battery unit eliminates the need for an external power supply and simplifies installation. The radio telemetry enables data transmission over distances of up to 20 metres in free field. The weatherproof housing (IP65) is designed for outdoor use.



# imc Telemetry Solutions Details

	T1	TEL1	TEL1-FLEX
application	one channel	one channel	one channel
distinction	economical	economical	flexible
max. channels per transmitter	1	1	1
max. channels per decoder / system	1	1	1
<b>technology</b>			
data transfer	inductive	inductive	inductive
reach	35 mm	35 mm	35 mm
resolution	16 bit	12 bit	12 bit
<b>power supply</b>			
inductive	●	●	●
battery			
DC supply voltage			
<b>output (decoder)</b>	<b>data acquisition with imc</b>		
analog +/- 10V	via voltage input	●	●
CAN	via CAN interface		
Ethernet	via TELDEC interface		
<b>configuration (parameterization)</b>			
Ethernet			
USB/RS232			
<b>data rate per transmitter</b>			
max. signal bandwidth	1.2 kHz	1.2 kHz	1.2 kHz
max. sampling rate	6.4 kHz	7 kHz	7 kHz
max. data rate			
<b>measured quantities and sensors</b>			
voltage	●	●	
IEPE			
strain gauge bridges	full / half	full / half	full / half
thermocouple		●	
PT100/PT1000	●		
<b>operating conditions</b>			
transmitter	-40 ... +85 °C	-40 ... +85 °C	-40 ... +85 (125) °C
receiver	-20 ... +70 °C	-20 ... +70 °C	-20 ... +70 °C

	D <sup>x</sup>	D <sup>x</sup> - HT	MTP-NT	CTP-NT-Rotate
application	multi-channel		multi-channel	multi-channel
distinction	modular		modular	mobile & rotating
max. channels per transmitter	4+2		2/4	8, 16, 32, 64
max. channels per decoder / system	20/24		256	64
<b>technology</b>				
data transfer	radio		inductive / radio	radio
reach	10 m		50 mm	20 m
resolution	16 bit		16 (18) bit	16 bit
<b>power supply</b>				
inductive	●		●	
battery	●		●	●
DC supply voltage	7 - 39 V DC		12 - 50 V DC	
<b>output (decoder) data acquisition with imc</b>				
analog +/- 10V	via voltage input	●	●	●
CAN	via CAN interface	●		
Ethernet	via TELDEC interface		●	●
<b>configuration (parameterization)</b>				
Ethernet	●			●
USB/RS232			●	
<b>data rate per transmitter</b>				
max. signal bandwidth	920 Hz	1 kHz	24 kHz	24 kHz
max. sampling rate	4.6 kHz	5 kHz	100 kHz	62.5 kHz
max. data rate			10 Mbit/s	5 Mbit/s
<b>measured quantities and sensors</b>				
voltage	●		●	●
IEPE			●	●
strain gauge bridges	full / half		full / half / quarter	full / half / quarter
thermocouple	●		●	●
PT100/PT1000	○		●/●	●/●
<b>operating conditions</b>				
transmitter	-40 ... +85 °C	-40 ... +125 °C	-40 ... +85 (125) °C	-40 ... +70 °C
receiver	-20 ... +65 °C	-20 ... +65 °C	-20 ... +70 °C	-20 ... +70 °C

Legend: ● standard, ○ optional

# Automotive Sensor Solutions

Enhancing Precision and Efficiency

## D<sup>x</sup>-BrakeTemp

Measuring Temperatures  
on the Brake Disc



## D<sup>x</sup>-Speed

Wireless Wheel Speed  
Acquisition



## D<sup>x</sup>-Power

Mechanical Power  
Measurements on Shafts

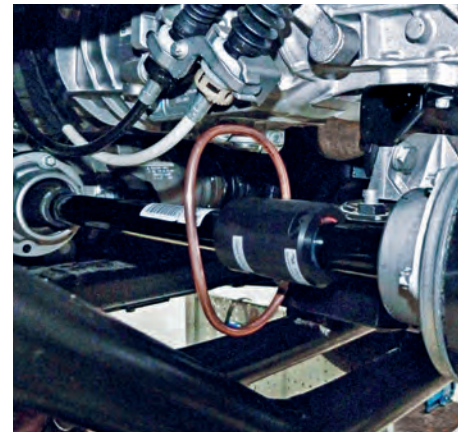

When it comes to comprehensive solutions, our commitment goes far beyond data acquisition hardware and software. Welcome to imc's innovative sensor solutions designed for a wide range of automotive applications. Whether you're engaged in vehicle dynamics tests, brake testing, or road load data acquisition, our portfolio includes a range of high-quality sensor solutions.



### **WFT-C<sup>x</sup>**

Robust Wheel Force Transducers



### **WTT-D<sup>x</sup>**

Wireless Wheel Torque Transducer

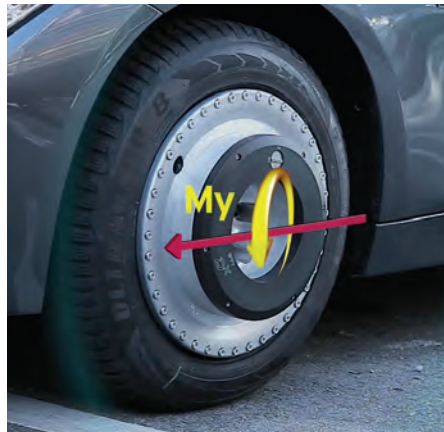

### **CLS<sup>x</sup>**

High-Precision Steering Effort Sensor



imc's sensors are specifically designed to simplify your work, from easy mounting and calibration to wireless data transmission to maximize your efficiency. Seamless integration with our DAQ platforms means you no longer have to worry about data synchronization and formats. Our sensors redefine excellence by optimizing your processes with every measurement.

# D<sup>x</sup>-BrakeTemp

## Measuring Temperatures on the Brake Disc



The D<sup>x</sup>-BrakeTemp is a high-precision tool for measuring temperatures on the wheels of road vehicles. All measurement signals, such as the temperatures at the brake disc, are **DIGITIZED DIRECTLY AT THE WHEELS** and transmitted telemetrically via vehicle mirror antennas to the receiver unit inside the vehicle. With its robust design, the system is also well-suited for harsh environments and road driving.

### D<sup>x</sup>-BrakeTemp Details

Accuracy	±1 K
Temperature range	-40 °C to 60 °C
Sensor inputs	3 or 6 thermocouples type J or K per wheel
Sampling rate	Up to 200Hz per channel with 3 channels per wheel
Measurement range	Typ K: to 1300 °C Typ J: to 1200 °C
Resolution	16 bit
Dimensions	Height: 50 mm Diameter: 100 mm
Mounting on the wheel	Collets on the wheel bolts
Power Supply	Rechargeable battery (up to 80 h)

# D<sup>x</sup>-Speed

## Wireless Wheel Speed Acquisition without reference point



The D<sup>x</sup>-Speed system conveniently acquires the wheel speed directly on vehicle wheels. The system does not require a stator or additional reference point and delivers measurement results – both on the test bench and outdoors – even in **HARSH CONDITIONS** such as mud, snow and dust. The accuracy is typically better than 0.5%. Impacts against the axle also will not affect the results. This means that even driving on rough roads is possible!

### D<sup>x</sup>-Speed Details

Maximum RPM	±7200 1/min
Accuracy	< 0.5 % at 10 °C to 50 °C
Temperature range	-40 °C to 60 °C
Weight	400 g
Dimensions	Height: 36 mm Diameter: 140 mm
Mounting on the wheel	Collets on the wheel bolts
Power Supply	Rechargeable battery (up to 80 h)

# D<sup>x</sup>-Power

## Mechanical power measurements

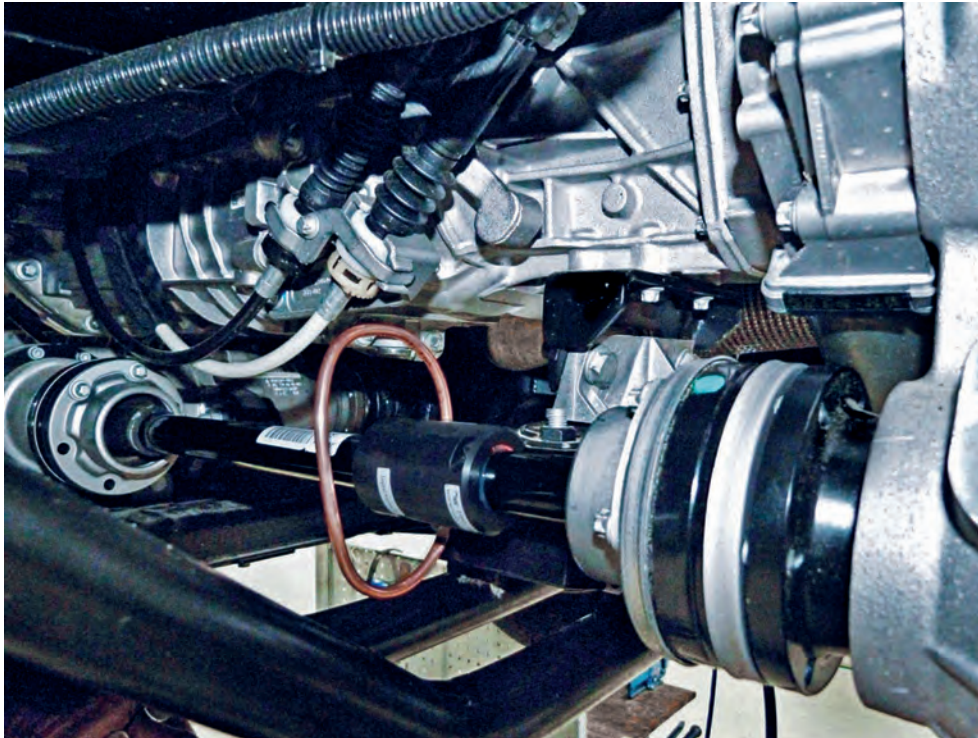

D<sup>x</sup>-Power in operation with ring stator for inductive supply

The D<sup>x</sup>-Power system allows making mechanical power measurements as easy as child's play. The transmitter unit (D<sup>x</sup>-SCT) is **MOUNTED DIRECTLY ON THE VEHICLE AXLE** by means of a half-shell housing. There it acquires the torque (via strain gauges) as well as the speed via an integrated rpm sensor. The measured data is transmitted telemetrically to the D<sup>x</sup>-receiver unit (RCI) inside the vehicle. This receiver unit calculates the synchronous values of the two signals in real time according to the formula, power = torque x rpm, and displays all values as physical variables.

### D<sup>x</sup>-Power Details

Maximum RPM	±7200 1/min
Accuracy	< 0.5 % at 10 °C to 50 °C
Temperature range	-40 °C to 85 °C (105 °C)
Torque measurement	Strain gauge
Power Supply	Rechargeable battery or inductive

# Services for Telemetry & Sensors

## Automotive Sensor Services



imc offers comprehensive services around its telemetry and sensor systems. We support you with the set-up of measurements, help with short processing times for calibrations and provide practical training. In addition, we offer our customers our in-depth know-how even in challenging applications.

You need a wheel force transducer, but only for a short period of time? Or do you simply want to get to know the WFT-C<sup>x</sup> and experience its capabilities in practice? imc can provide you a **RENTAL OPPORTUNITY** for the appropriate device. In addition, our specialists will be happy to assist you if required.



### Calibration

imc calibrates each WFT-C<sup>x</sup> on its own specifically developed test bench. Each force and torque is measured separately. Interactions (crosstalk) between the measured variables can thus be detected and compensated for. This results in an unprecedented precision of the measured values (crosstalk, non-linearity, hysteresis: all below 0.2%).

# WFT-C<sup>x</sup>

## Wheel Force Transducer

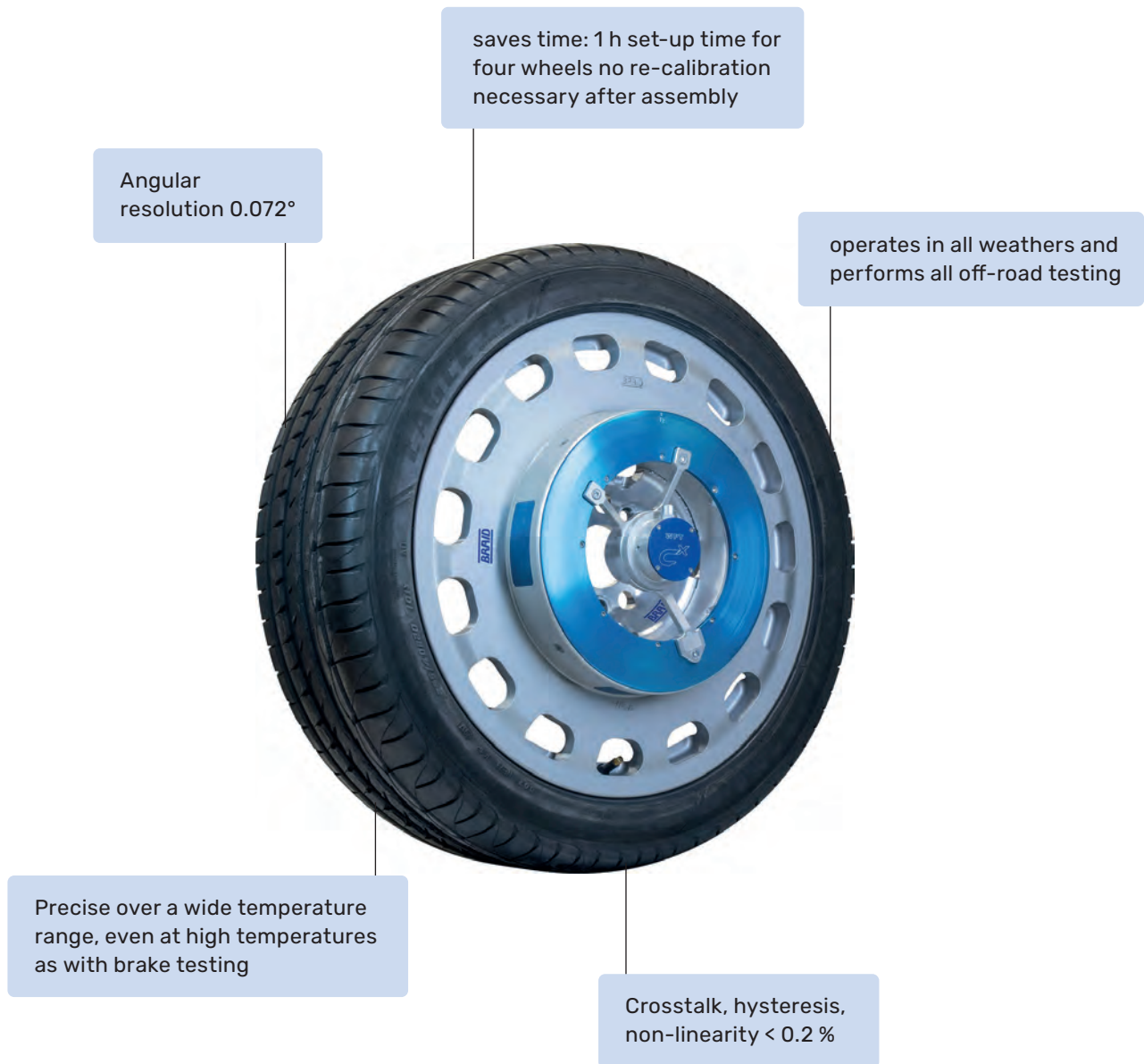

Whether vehicle dynamic tests, brake tests or determination of load spectra - the 6-component **WHEEL FORCE TRANSDUCER** WFT-C<sup>x</sup> acquires all forces and torques acting on the vehicle with high precision. The robust housing reliably protects against dirt, water and snow and allows applications in any weather.

## APPLICATION

Ideal for road testing and test stands

**precise • robust • quick setup**



one sensor for most vehicles and test benches



protection rating: IP67  
100 g shock resistance

Synchronous acquisition  
of all wheel sensors

With the flexible adapter system, the WFT-C<sup>x</sup> can be used with minimal effort on a variety of vehicle types - **FROM COMPACT CARS TO SUVs** and light trucks - even on the test bench. A quick system setup and convenient software functions, such as zero calibration, allow the system to be test-ready within a very short time

# WFT-C<sup>x</sup>

## Wheel Force Transducer



Our Wheel Force Transducers are built to withstand challenging environmental conditions. With a wide temperature range of  $-40^{\circ}\text{C}$  to  $+105^{\circ}\text{C}$  and a waterproof design, they excel in adverse weather conditions, including ice, snow, and meltwater. The robust construction and impact resistance of up to 100 g make them ideal for testing on rough terrains.

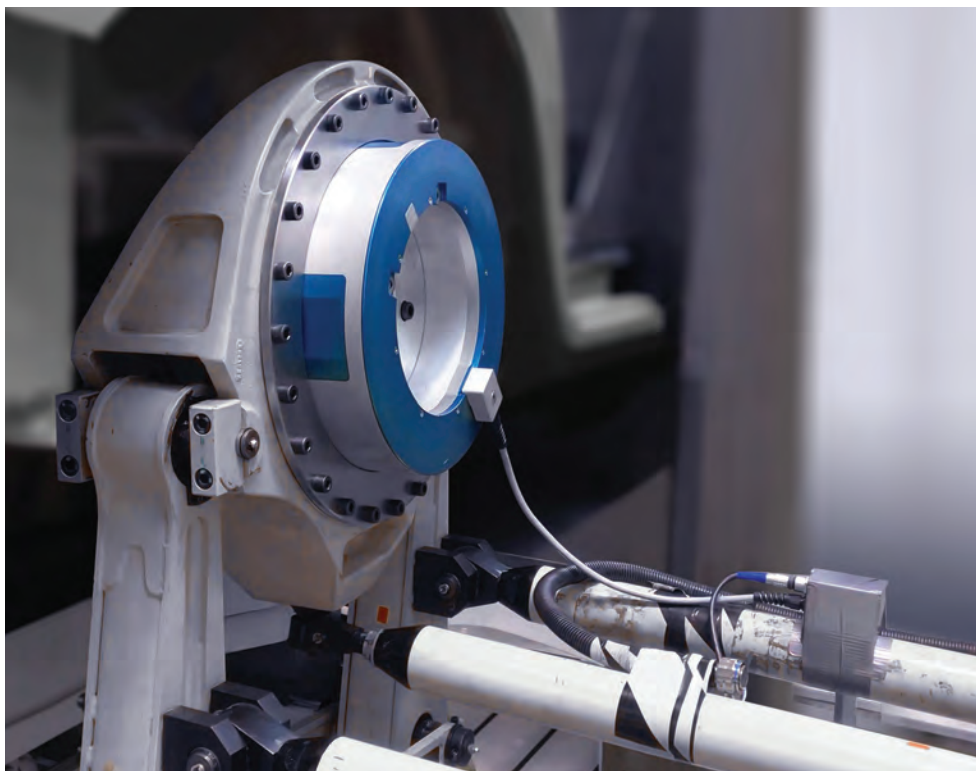

A WFT for component lifetime **TESTING ON THE TEST STAND** must be durable. Especially for these applications, imc offers WFT sensors made of titanium or steel. If a rotating measurement is carried out on a chassis dyno or on a road test, the wired signal transmission to the control unit is simply replaced by a stator. Since all of the WFT sensor housing types have the same dimensions, existing adapters can be used for all types.

## APPLICATION

Ideal for road testing and test stands

**precise • robust • quick setup**

## WFT-C<sup>x</sup> wheel force transducer

Parameter	Value			
	Aluminium	WFT-C <sup>x</sup> Titanium	Steel PH17-4	WFT-C <sup>xs</sup> Aluminium
Measurement principle	temperature compensated strain gauge application			
Measurement range: forces	F <sub>x</sub> , F <sub>z</sub> = ± 45 kN F <sub>y</sub> = ± 25 kN	F <sub>x</sub> , F <sub>z</sub> = ± 60 kN F <sub>y</sub> = ± 30 kN	F <sub>x</sub> , F <sub>z</sub> = ± 60 kN F <sub>y</sub> = ± 30 kN	F <sub>x</sub> , F <sub>z</sub> = ± 25 kN F <sub>y</sub> = ± 20 kN
Measurement range: torques	M <sub>x</sub> , M <sub>y</sub> , M <sub>z</sub> = ± 8,75 kNm	M <sub>x</sub> , M <sub>y</sub> , M <sub>z</sub> = ± 10 kNm	M <sub>x</sub> , M <sub>y</sub> , M <sub>z</sub> = ± 10 kNm	M <sub>x</sub> , M <sub>y</sub> , M <sub>z</sub> = ± 6 kNm
Protection rating	IP66, IP67			
Sampling rate per channel	up to 5 kHz			
Angular resolution with 5000 increments	0,072 °			
Linearity	< 0.2 % FS			
Hysteresis	< 0.2 % FS			
Crosstalk	< 0.2 % FS			
Low pass filter	6-pol Butterworth filter, cut-off frequency 1200 Hz			
Weight without adapter (ca.)	7.5 kg	10.5 kg	17.5 kg	5.9 kg
Rim diameter	min. 14" (356 mm), 13" upon request			
Hub diameter with adapter	max. 5.5"			
Operating temperature sensor	- 40 °C to + 150 °C			
Operating temperature electronics	- 40 °C to + 105 °C			
Mechanical load	Stress analysis according to BMW QV 36026			
Shock proof	max. 100 g			
Rotational speed	3000 rpm			
Safety	mechanical breakage protection			
Dimensions:				
- Outer diameter (w/o adapter)	317.5 mm			
- Inner diameter (w/o adapter)	203 mm			
- Height	76 mm			61.5 mm
Temperature drift	0.005 % / °C			
Mounting bolts	32 Pieces			
Adaption	customer-specific adaption for any vehicle possible			

### Synchronized Data Acquisition with imc CRONOSflex

Facilitate seamless data acquisition from two WFT-C<sup>x</sup> wheel force transducers through the WFT-2 Module. It is simply clicked on an imc CRONOSflex system and is automatically synchronized with all other connected sensors, field buses, GPS systems, etc. Configuration, calibration and zeroing is effortless with the imc STUDIO software. A CRONOSflex supports up to three WFT-2 modules, accommodating a total of six wheel force transducers. This modular setup provides a compact, comprehensive solution for diverse vehicle applications.

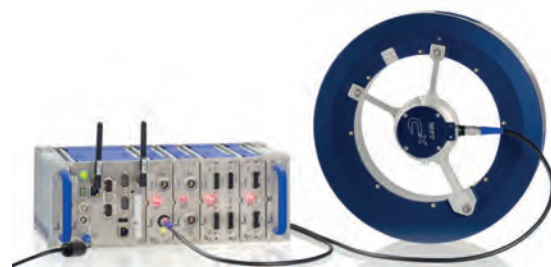

# WTT-D<sup>x</sup>

## Wheel Torque Transducer

### Acquire drive and output torques directly at the wheel

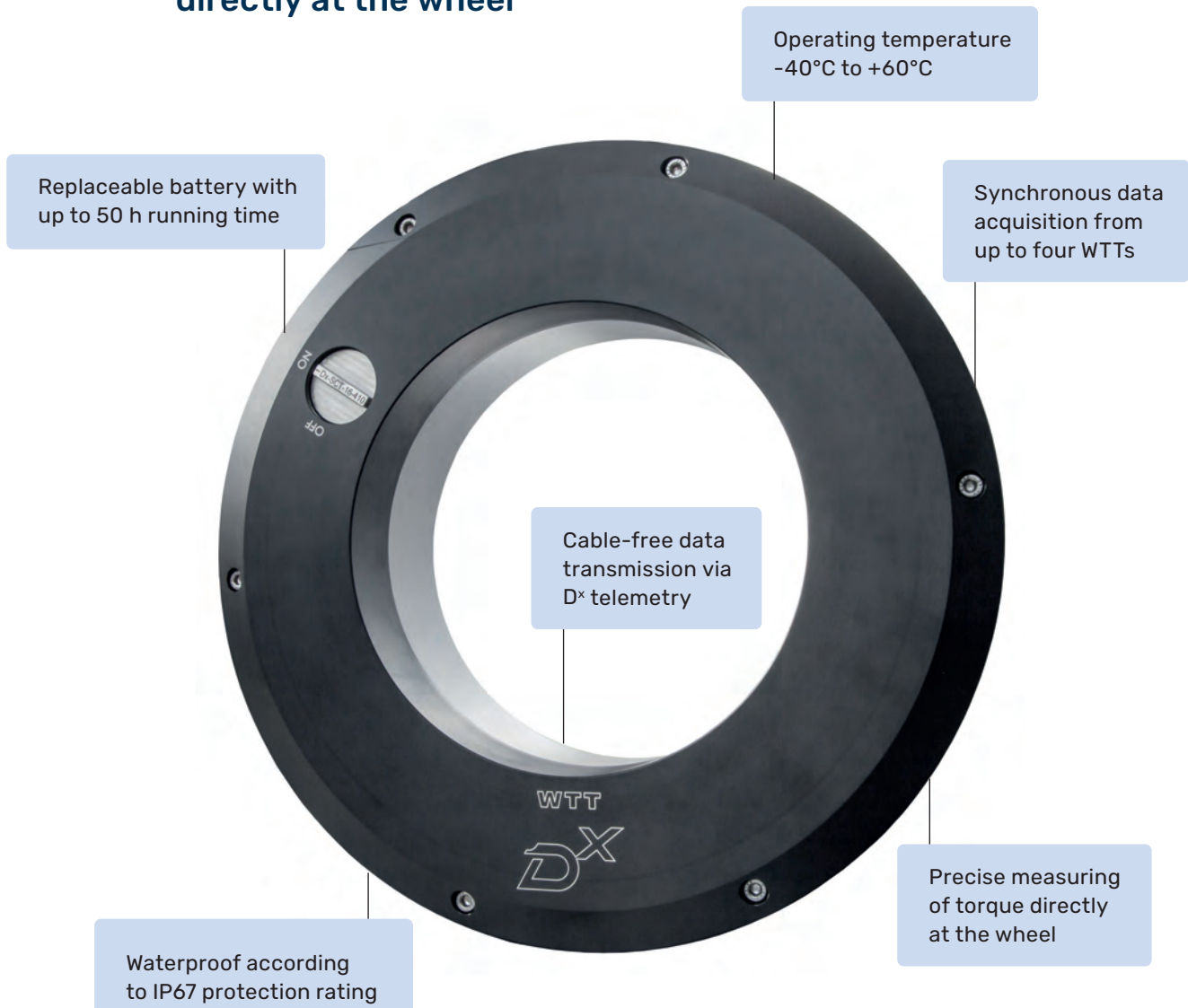

In automotive development, it is important to know the **EXACT TORQUES** acting on the vehicle – especially under acceleration and braking maneuvers. With the WTT-D<sup>x</sup> wheel torque transducer, a high-precision tool is available for making such measurements. The WTT detects the mechanical load directly where it is produced: the wheels that form the interface between the vehicle and the road.

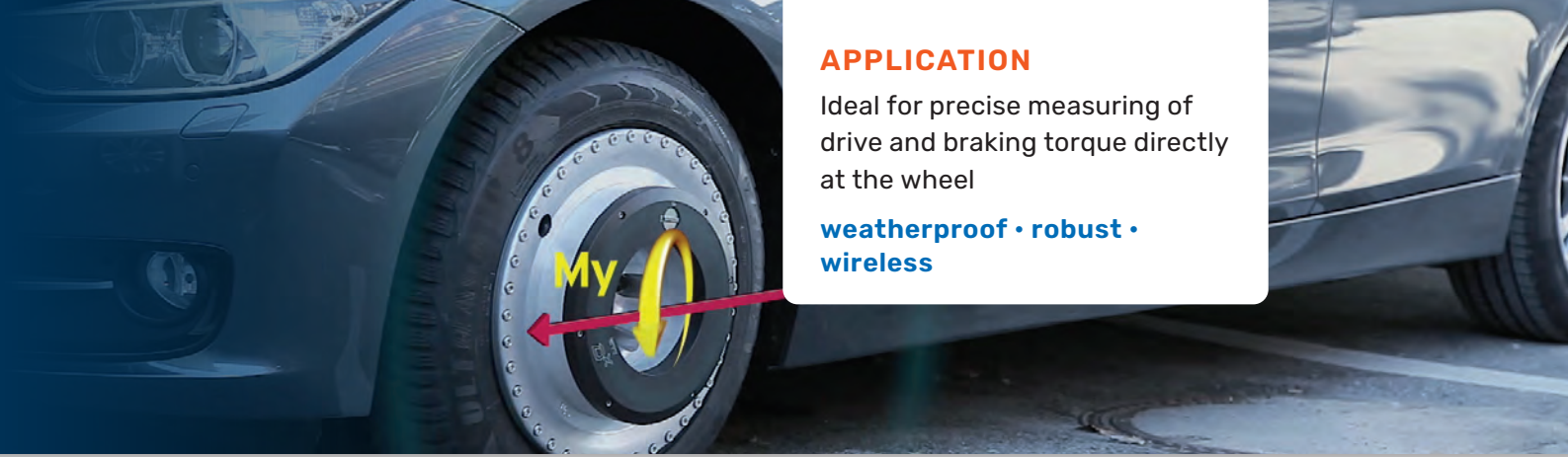

## APPLICATION

Ideal for precise measuring of drive and braking torque directly at the wheel

**weatherproof • robust • wireless**

## WTT-D<sup>x</sup> wheel torque transducer Details

Parameter	Value
Measurement value	torque in axial direction $M_y$
Signal transmission	digital-telemetric
Measurement range	$M_y = \pm 6000 \text{ Nm}$ , optional, $M_y = \pm 3000 \text{ Nm}$
Bandwidth	max. 1 kHz
Linearity	< 0.5 %
Hysteresis	< 0.5 %
Crosstalk	< 0.5 %
Sensor diameter	300 mm
Sensor weight	ca. 4.75 kg (incl. telemetry unit) ca. 6.3 kg (with battery)
Sensor housing material	aluminum
Mechanical load	stress analysis according to AK-LH-08 4.34
Rim diameter	min. 13"
Hub diameter with adapter	max. 6"
Operating temperature	-40°C to 60°C
Rotational speed	2500 rpm
Shock proof	100 g
Protection rating	IP67 (waterproof)
Mounting and balancing	Yes (wheel bolts accessible)
Power supply	Up to 50 h
Interfaces	Analog and CAN

# CLS<sup>x</sup> steering effort sensor

High-Precision Steering Effort Sensor

World's smallest and lightest steering effort sensor

Ultra slim sensor body design for seamless integration with minimal extension of steering column

Steering torque range  
 $\pm 100$  Nm or  $\pm 200$  Nm  
(up to  $\pm 250$  Nm as option)

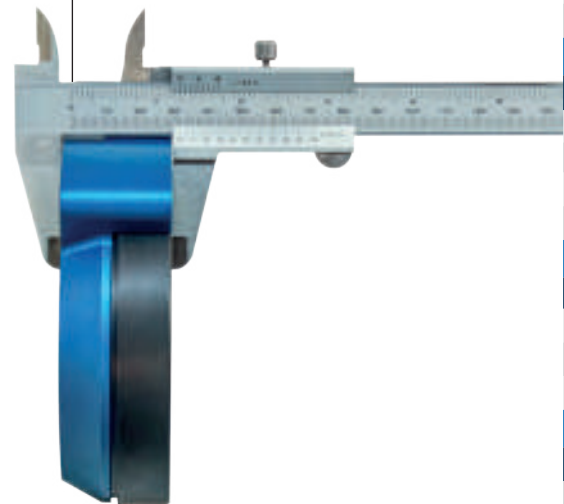

Detects torque, angle and rotational velocity

Acceleration measurement in X, Y & Z directions

Optimized for autonomous driving tests

Measuring angle range  $\pm 1440^\circ$

With the innovative CLS<sup>x</sup> steering effort sensor, the original steering wheel of your vehicle becomes a high-precision instrument that measures steering torque, angle, steering velocity and acceleration in x, y and z directions. The **ULTRA-SLIM SENSOR** can be placed between the steering column and steering wheel in just a few simple steps. High-resolution A/D converters with 24 bits ensure especially good signal quality and noise-free results even at small torques below 3 Nm. This is particularly important when testing advanced driver assistance systems and autonomous driving to determine the overpressure torque.



## APPLICATION

Ideal for testing steering systems, driver assistance systems and autonomous driving

**precise • ultra-slim • quick setup**

## CLS<sup>x</sup> Details

### Steering torque

Parameter	Value	Remarks
Measuring principle	temperature compensated strain gauge application	
Measurement range	±100 Nm, ±200 Nm, ±250 Nm	others upon request
Accuracy	0.1% FS	Combined (gain error and non-linearity)
Bandwidth	0 to 800 Hz	sampling rate 5 kHz

### Steering angle

Parameter	Value	Remarks
Measuring principle	incremental angle encoder	
Measurement range	±1440 °	
Accuracy	0.045 °	
Bandwidth	0 to 800 Hz	sampling rate 5 kHz

### Steering velocity (angular velocity)

Parameter	Value	Remarks
Measuring principle	calculated from angle	
Measurement range	±2048 °/s	
Bandwidth	0 to 800 Hz	sampling rate 5 kHz

### Vibration and acceleration

Parameter	Value	Remarks
Vibration	in the center of the steering column, measurement range up to 5 g in x, y and z direction	
Rotational acceleration	measurement range ±10000 °/s <sup>2</sup>	

### General data

Parameter	Value	Remarks
Sensor height	approx. 30 mm	without adapter
Sensor weight	approx. 0.6 kg	without adapter
Overload	>100% of the measurement range	
Mech. breaking torque	>500 Nm	
Adaption	special adaption sets for any car or truck manufacturer available	
Moment of inertia Sensor Steering wheel or column adapter	approx. 3000 g cm <sup>2</sup> typ. approx. 500 g cm <sup>2</sup>	
Working temperature	-20°C to +80°C	

### Control unit

Parameter	Value	Remarks
Supply	9 to 36 V DC	
CAN output	freely configurable	
Analog output	freely configurable, max. ±10 V	
Auto zero	Via remote control or push-button for torque and angle on the control unit	

# imc SERVICES

From Experts for Experts

## CONSULTING & TRAINING

With our global team of measurement experts, we support you in all phases of your testing tasks with consulting and training.

## MEASURING SERVICE

For occasional tests, it is often not worthwhile to purchase your own test equipment. For this purpose, we offer contract measurements as a service.



As a **SOLUTION PROVIDER**, imc provides an additional range of services. These include project consulting, contract measurements, data evaluation, outsourcing of specialists and customer-specific software development through to system integration and test bench automation.

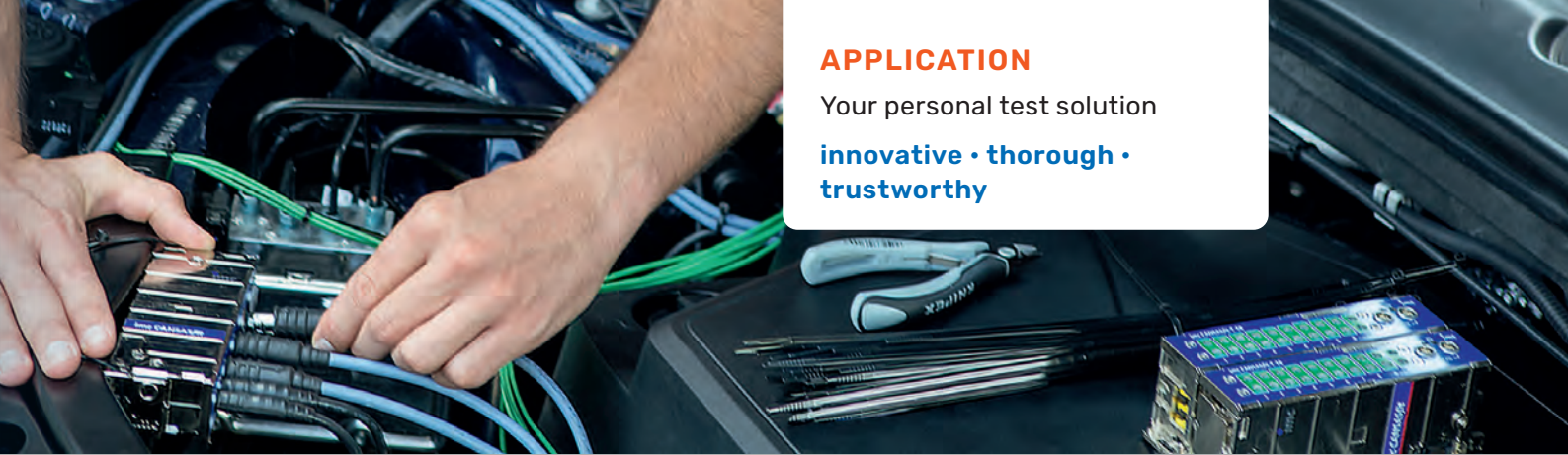

## APPLICATION

Your personal test solution

innovative · thorough ·  
trustworthy

## SOFTWARE DEVELOPMENT

We develop tailor-made software for you  
- whether customer-specific analyses,  
connecting databases, integrating third-party  
devices or complex test bench controls.

## TEST STANDS

We develop customized test benches for  
research, development and production -  
whether for component testing, quality  
assurance or life cycle testing.



Our **GLOBAL TEAM OF ENGINEERS** is dedicated to working with you throughout all phases of project development - including planning, construction, configuration, and implementation. By our extensive project experience and a high level of competence in solving test and measurement tasks, we want users to reach their testing goals faster and more efficiently.

## About imc Test & Measurement

imc Test & Measurement GmbH is a manufacturer and solution provider of productive test and measurement systems. Together with its customers from the fields of automotive engineering, mechanical engineering, railway, aerospace and energy, imc implements metrological solutions for research, development, service and production.

Our customers use imc measurement devices, software solutions and test stands to validate prototypes, optimize products, monitor processes and gain insights from measurement data.

imc Test & Measurement is part of Axiometrix Solutions, a leading test solutions provider comprised of globally-recognized measurement brands like GRAS Sound & Vibration and Audio Precision.

### Contact us:

imc Test & Measurement GmbH  
Voltastraße 5  
D-13355 Berlin  
Germany  
[www.imc-tm.com](http://www.imc-tm.com)

